



## Verkehrsschilder *Signaux routiers*

Edition 02.2024

## VSS

Wir beraten und signalisieren nach gültigen VSS-Normen (SN/EN) und der Signalisationsverordnung SSV.  
*Nous conseillons et signalisons conformément aux normes VSS(SN/EN) et à l'ordonnance sur la signalisation routière (OSR) en vigueur.*

### Klassen und Ausgestaltung von Signalen (SN 640 871) Classes et équipement des signaux (SN 640 871)

Klasse / Classe Ausgestaltung / Equipement

R1	Retroreflektierend / Action rétro réfléchissante
R2	Stark retroreflektierend / Forte action rétro réfléchissante
R3	Sehr stark retroreflektierend / Très forte action rétro réfléchissante

### Mindestanforderungen für retroreflektierende Signale auf Haupt- und Nebenstrassen Exigences minimales pour les signaux en matière de rétro réflexion sur les routes principales et secondaires

Strassentyp Type de route	Signale für den fliessenden Verkehr Signaux pour une circulation fluide			Signale für den ruhenden Verkehr Signaux pour une circulation peu fluide
	Strassenrand Bord de la chaussée	Überkopf Au dessus des véhicules	Tunnel Tunnel	
Autobahnen, Autostrassen Autoroutes, routes	R2 / R3	R2 / R3	R3 / I*	R2
Hauptstrasse, Nebenstrassen Rues principales, routes secondaires	R2	R2	R2 / R3	R1
Unbedeutende Nebenstrassen Routes secondaires insignifiantes	R1	R1	R1	R1

Fett markiert = die empfohlene Anforderung, I\* = innen ausgeleuchtete Signale  
*En gras = option recommandée, I\* = signaux à éclairage intérieur*

## EN 12899

Wir sind EN 12899 zertifiziert und fertigen unsere Produkte gemäss Vorgaben.  
*Nous sommes certifiés EN 12899 et fabriquons nos produits selon spécifications.*

## ISO 9001

Mit dem ganzheitlichen Managementsystem stellen wir sicher, dass unsere Produkte und Dienstleistungen konsequent den Qualitätsanforderungen der Kunden entsprechen und die Aspekte Sicherheit und Gesundheit konstant gelebt werden.  
*Grâce au système de management global, nous pouvons garantir que les produits et prestations de services sont pleinement conformes aux exigences de qualité de la clientèle et que les aspects de sécurité et de santé font constamment l'objet d'une attention soutenue.*

## ISO 14001

Mit dem betrieblichen Umweltmanagementsystem (UMS) leisten wir einen Beitrag zur Schonung der Umwelt und zur Steigerung der Lebensqualität und stellen ein geordnetes Recycling von Abfällen sicher.  
*Grâce au système de management environnemental (SME), nous apportons une contribution à la protection de l'environnement et à l'amélioration de la qualité de vie et assurons un recyclage convenable des déchets.*

## ISO 45001

Die Norm ISO 45001 regelt die gültigen Kriterien für die Bewertung eines Managementsystem für Sicherheit und Gesundheit bei der Arbeit. Mit der Erfüllung dieser Norm stellen wir sicher, dass unser sicherheitsgerechtes Verhalten in den Unternehmensprozessen integriert ist. Mit dem ISO 45001 Zertifikat erfüllen wir gleichzeitig auch die EKAS Richtlinie 6508.  
*ISO 45001, valable depuis 1999, a établi un certain nombre de critères d'évaluation d'un système de management de la santé et de la sécurité au travail. Elle est en mesure de montrer que le comportement de chacun, adapté aux contraintes liées à la sécurité, est intégré dans les processus internes. Avec le certificat ISO 45001 nous remplissons en même temps les conditions de la directive CFST 6508.*

## Produkte – Normen Produits – normes



Die nachfolgend aufgeführten Produkte der Signal AG, entsprechen den zurzeit anwendbaren Normen (EN 12899, EN 12966, EN 1090) für die Verwendung bei der Strassensignalisation und sind entsprechend einzusetzen. Ein über diesen Verwendungszweck hinausgehender Gebrauch oder Einsatz der Produkte erfolgt auf eigenes Risiko des Verwenders, jegliche Haftung der Signal AG ist ausgeschlossen.  
 Die in dem Produktsortiment enthaltenen Daten, Beschreibungen und Abbildungen entsprechen dem Zeitpunkt der Drucklegung. Änderungen vorbehalten!

*Les produits de Signal SA énumérés ci-dessous sont conformes aux normes actuellement en vigueur (EN 12899, EN 12966, EN 1090) pour une utilisation dans le domaine de la signalisation routière et doivent être installés en conséquence. Une utilisation ou une installation des produits qui dépasse l'usage prévu se fait sous la seule responsabilité de l'utilisateur ; Signal SA décline toute responsabilité à cet égard.  
 Les données, descriptions et illustrations contenues dans le catalogue de produits correspondent à celles qui sont applicables au moment de l'impression. Sous réserve de modifications !*



Seite / page

## Allgemeine Signale Signaux routiers

4		Gefahrensignale und Vortrittssignale (Kombinationen) / <i>Signaux de danger et de priorité (combinaisons)</i>
6		Vortrittssignal «Kein Vortritt» (Kombinationen) / <i>Signal de priorité «cédez le passage» (combinaisons)</i>
8		Vorschriftssignale (Kombinationen) / <i>Signaux de prescription (combinaisons)</i>
13		Zusatztafeln / <i>Plaques complémentaires</i>
14		Vortrittssignal "Stop" (Kombinationen) / <i>Signal de priorité "Stop" (combinaisons)</i>
15		Vortrittssignale (Kombinationen) / <i>Signaux de priorité (combinaisons)</i>
16		Vorschrifts-, Hinweis-, Vortrittssignale / <i>Signaux de prescription, d'indication et de priorité</i>
21		Wegweisung (Kombinationen) / <i>Indicateur de direction (combinaisons)</i>
22		Grossflächige Tafeln / <i>Panneaux à grande surface</i>
26		Zusatztafeln / <i>Plaques complémentaires</i>
28		Bahnübergangs-Signalisation / <i>Signalisation des passage à niveau</i>









## Schiffahrtssignale Signalisation fluviale

30	div.	Verbots-, Gebots- und Hinweiszeichen / <i>Signaux de prescription, d'obligation et d'indication</i>
32	div.	Zusätzliche Schilder und Anschriften / <i>Panneaux et inscriptions supplémentaires</i>

## Diverse Signale Signaux divers

32	div.	Gefahren- und Verbotsschilder / <i>Signaux de danger et d'interdiction</i>
35	div.	"Hunde"-Tafeln / <i>Panneaux "chien"</i>
36	div.	Diverse Schilder / <i>Panneaux divers</i>































## Signalträger Supports pour signaux

38		System Signaflex und geschweisste Signalträger / <i>Système Signaflex et supports pour signaux soudés</i>
45		Wechselrahmen Clip / <i>Panneau à Clip</i>
47		Einzelteile zu Signaflex / <i>Pièces détachées pour Signaflex</i>
49		Signalträger mit Jordahlschienen Typ J / <i>Supports pour signaux avec glissières "Jordahl" type J</i>
51		Signalträger mit seitlicher Befestigung Typ C / <i>Supports pour signaux à fixation latérale type C</i>
53		Halterungen / <i>Fixations</i>
54		Rohrmasten / <i>Mâts tubulaires</i>
55		Verankerungen / <i>Ancrages (fondations)</i>



# Signaltafeln Signaux

## Gefahren-, Vortrittssignale Signaux de danger et de priorité

							
<b>1.01</b> Rechtskurve <i>Virage à droite</i>	<b>1.02</b> Linkskurve <i>Virage à gauche</i>	<b>1.03</b> Doppelkurve nach rechts beginnend <i>Double virage, le premier à droite</i>	<b>1.04</b> Doppelkurve nach links beginnend <i>Double virage, le premier à gauche</i>	<b>1.05</b> Schleudergefahr <i>Chaussée glissante</i>	<b>1.06</b> Unebene Fahrbahn <i>Cassis</i>		
							
<b>1.07</b> Engpass <i>Chaussée rétrécie</i>	<b>1.08</b> Verengung rechts <i>Chaussée rétrécie à droite</i>	<b>1.09</b> Verengung links <i>Chaussée rétrécie à gauche</i>	<b>1.10</b> Gefährliches Gefälle <i>Descente dangereuse</i>	<b>1.11</b> Starke Steigung <i>Forté montée</i>	<b>1.12</b> Rollsplit <i>Gravillon</i>	<b>1.13</b> Steinschlag von rechts <i>Chute de pierres à droite</i>	<b>1.13A</b> Steinschlag von links <i>Chute de pierres à gauche</i>
							
<b>1.14</b> Baustelle <i>Travaux</i>	<b>1.15</b> Schranken <i>Barrières</i>	<b>1.16</b> Bahnübergang ohne Schranken <i>Passage à niveau sans barrières</i>	<b>1.18</b> Strassenbahn <i>Tramway ou chemin de fer</i>	<b>1.22</b> Fussgängerstreifen <i>Passage pour piétons</i>	<b>1.23</b> Kinder <i>Enfants</i>	<b>1.24</b> Wildwechsel <i>Passage de gibier</i>	<b>1.25F</b> Tiere (Frosch) <i>Animaux (grenouille)</i>
							
<b>1.25K</b> Tiere (Kuh) <i>Animaux (vache)</i>	<b>1.25P</b> Tiere (Pferd) <i>Animaux (cheval)</i>	<b>1.26</b> Gegenverkehr <i>Circulation en sens inverse</i>	<b>1.27</b> Lichtsignale <i>Signaux lumineux</i>	<b>1.30</b> Andere Gefahren <i>Autres dangers</i>	<b>1.31</b> Stau <i>Bouchon</i>	<b>1.32</b> Radfahrer <i>Cyclistes</i>	
							
<b>3.05</b> Verzweigung mit Strasse ohne Vortritt <i>Intersection avec une route sans priorité</i>	<b>3.06</b> Verzweigung mit Rechtsvortritt <i>Intersection comportant la priorité de droite</i>						

### Weitere Vortrittssignale: Autres signaux de priorité:

Seite/page

6 10 14 15 17



### Bestellinformationen Informations de commande

<b>Signal Formate (mm)</b> <i>Formats signal (mm)</i>	△ 600 △ 900 △ 1200 △ 1500
--	------------------------------------





<b>Material, Beschichtung</b> <i>Matériau, revêtement</i>	AH (Alu, R2) AV (Alu, R3)
--	------------------------------

<b>Preisliste</b> <i>Liste de prix</i>	<b>P1-1</b>
---	-------------

### Verweise/Renvois

<b>Zusatztafeln</b> <i>Plaques complémentaires</i>	
	Seite/page 26

### Rahmen und Ständer Cadres et supports

	Seite page		Seite page
 <b>Signaflex M13F</b> (600, 900)	<b>38</b>	 <b>R325J</b> Jordahlschienen/ <i>glissières "Jordahl"</i> (600, 900, 1200, 1500)	<b>49</b>
 <b>Signaflex M13FA</b> (600, 900)	<b>38</b>	 <b>R323C</b> (600, 900)	<b>51</b>

# Signaltafeln Signaux

## Gefahren- bzw. Vortrittssignale kombiniert Signaux de danger et de priorité combinés

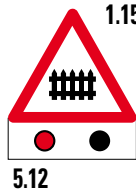
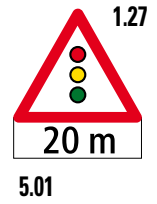

Beispiele  
Exemples

### Bestellinformationen Informations de commande

<b>Signal Formate (mm)</b> <i>Formats signal (mm)</i>	600 = 600 + 560 x 200
	900 = 900 + 840 x 250
	1200 = 1200 + 1140 x 400
	1500 = 1500 + 1440 x 500 (Standard: Radius/rayon R=30)
<b>Material, Beschichtung</b> <i>Matériau, revêtement</i>	AH (Alu, R2)
	AV (Alu, R3)
<b>Preisliste</b> <i>Liste de prix</i>	<b>P1-24</b>

### Rahmen und Ständer Cadres et supports

	Seite page	Seite page
<b>Signaflex M14F</b> (600, 900)	<b>38</b>	<b>Signaflex M14FA</b> (600, 900) <b>38</b>
<b>R326J</b> Jordahlschienen/ <i>glissières "Jordahl"</i> (600, 900, 1200, 1500)	<b>49</b>	<b>R324C</b> (600, 900) <b>51</b>

# Signaltafeln Signaux

## Vortrittssignal «Kein Vortritt» Signal de priorité «cédez le passage»



3.02  
Kein Vortritt  
Cédez le passage

Weitere Vortrittssignale:  
Autres signaux de priorité:

Seite/page

4 10 14 15 17



### Bestellinformationen Informations de commande

Signal Formate (mm) Formats signal (mm)	<input type="checkbox"/> 600 <input type="checkbox"/> 900 <input type="checkbox"/> 1200 <input type="checkbox"/> 1500
--	--

Material, Beschichtung Matériau, revêtement	AH (Alu, R2) AV (Alu, R3)
--	------------------------------

Preisliste Liste de prix	<b>P1-1</b>
-----------------------------	-------------

### Verweise/Renvois

Zusatztafeln Plaques complémentaires	<input type="checkbox"/> <input type="checkbox"/> <input type="checkbox"/> <input type="checkbox"/> Seite/page 26 28 8 26
---	--

### Rahmen und Ständer Cadres et supports

	Seite page		Seite page
<b>Signaflex M17F</b> (600, 900)	39	<b>R325J</b> Jordahlschienen/glissières "Jordahl" (600, 900, 1200, 1500)	49
<b>Signaflex M17FA</b> (600, 900)	39	<b>R323C</b> (600, 900)	51

## Signal «Kein Vortritt» kombiniert Signal «cédez le passage» combiné

Beispiel  
Exemple

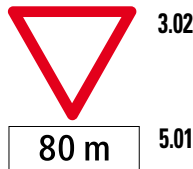

### Bestellinformationen Informations de commande

Signal Formate (mm) Formats signal (mm)	<input type="checkbox"/> 600 + 560 x 200 <input type="checkbox"/> 900 + 840 x 250 <input type="checkbox"/> 1200 + 1200 x 400 <input type="checkbox"/> 1500 + 1500 x 500
--	--

Material, Beschichtung Matériau, revêtement	AH (Alu, R2) AV (Alu, R3)
--	------------------------------

Preisliste Liste de prix	<b>P1-1</b> + <b>P1-17</b>
-----------------------------	----------------------------

### Verweise/Renvois

Zusatztafeln Plaques complémentaires	<input type="checkbox"/> Seite/page 26
---	---

### Rahmen und Ständer Cadres et supports

	Seite page		Seite page
<b>Signaflex M17F + R348J</b> (600 + 560x200, 900 + 840x250)	39, 50	<b>Signaflex M17F + R349J*</b> (600 + 560x200)	39, 50
<b>R325J + R349J*</b> Jordahlschienen/glissières "Jordahl" (600 + 560x200)	49, 50	<b>R325J + R348J</b> Jordahlschienen/glissières "Jordahl" (600 + 560x200, 900 + 840x250)	49, 50
<b>R374C</b> (600, 900)	51	<b>R325J + R392J</b> Jordahlschienen/glissières "Jordahl" (1200 + 1200x400, 1500 + 1500x500)	49, 50

\* günstige Variante zu R348J/Variante à prix réduit par rapport à R348J

# Signaltafeln Signaux

## Signal «Kein Vortritt» kombiniert Signal «cédez le passage» combiné

Beispiel  
Exemple

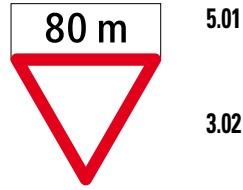

### Bestellinformationen Informations de commande

Signal Formate (mm) Formats signal (mm)	▽ 600 = 600 + 560 x 200
	▽ 900 = 900 + 840 x 250
	▽ 1200 = 1200 + 1140 x 400
	▽ 1500 = 1500 + 1440 x 500
(Standard: Radius/rayon R=30)	





Material, Beschichtung Matériau, revêtement	AH (Alu, R2) AV (Alu, R3)
--	------------------------------

Preisliste Liste de prix	<b>P1-24</b>
-----------------------------	--------------

### Verweise/Renvois

Zusatztafeln Plaques complémentaires	
Seite/page	26

### Rahmen und Ständer Cadres et supports

	Seite page		Seite page
 Signaflex M18F (600, 900)	39	 R326J Jordahlschienen/glissières "Jordahl" (600, 900, 1200, 1500)	49
 Signaflex M18FA (600, 900)	39	 R324C (600, 900)	51

## Signal «Kein Vortritt» kombiniert Signal «cédez le passage» combiné

Beispiele  
Exemples

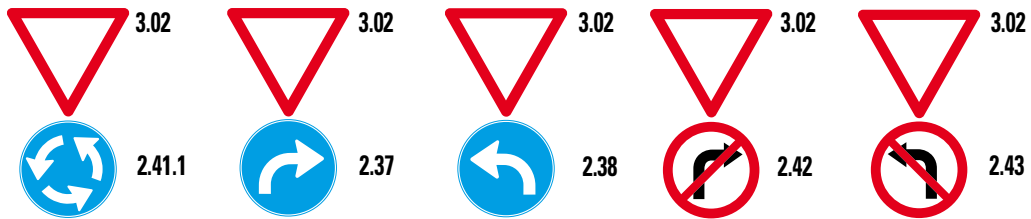

### Bestellinformationen Informations de commande

Signal Formate (mm) Formats signal (mm)	▽ 600 + ○ 400
	▽ 900 + ○ 600
	▽ 1200 + ○ 900
	▽ 1500 + ○ 1200



Material, Beschichtung Matériau, revêtement	AH (Alu, R2) AV (Alu, R3)
--	------------------------------

Preisliste Liste de prix	<b>P1-1</b> + <b>P1-36</b>
-----------------------------	----------------------------

### Verweise/Renvois

Zusatztafeln Plaques complémentaires	
Seite/page	8

### Rahmen und Ständer Cadres et supports

	Seite page		Seite page
 Signaflex M17F + R347J (600 + 400, 900 + 600)	39, 49	 R325J + R347J Jordahlschienen/glissières "Jordahl" (600 + 400, 900 + 600, 1200 + 900, 1500 + 1200)	49
 R54117C (600, 900)	51		

# Signaltafeln Signaux

## Signal «Kein Vortritt» kombiniert Signal «cédez le passage» combiné



3.02

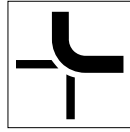

5.09

Richtung der Hauptstrasse  
Direction de la route principale

Beispiel  
Exemple

### Bestellinformationen Informations de commande

Signal Formate (mm) Formats signal (mm)	▽ 600 + 600 x 600
	▽ 900 + 900 x 900
	▽ 1200 + 1200 x 1200
	▽ 1500 + 1500 x 1500
	(Standard: Radius/rayon R=30)

Material, Beschichtung Matériau, revêtement	AH (Alu, R2) AV (Alu, R3)
--	------------------------------

Preisliste Liste de prix	<b>P1-1</b> + <b>P1-19</b>
-----------------------------	----------------------------

### Verweise/Renvois

Zusatztafeln Plaques complémentaires	 Seite/page 28
---	--

### Rahmen und Ständer Cadres et supports

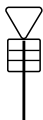
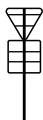
	Seite page		Seite page
 <b>Signaflex M17F + R362J</b> (600 + 600x600, 900 + 900x900)	<b>39,</b> <b>49</b>	 <b>R325J + R362J</b> Jordahlschienen/glisières "Jordahl" (600 + 600x600, 900 + 900x900, 1200 + 1200x1200, 1500 + 1500x1500)	<b>49</b>

## Vorschriftssignale Signaux de prescription



**2.01**  
Allgemeines Fahrverbot  
Interdiction générale de circuler dans les deux sens



**2.02**  
Einfahrt verboten  
Accès interdit



**2.03**  
Verbot für Motorwagen  
Circulation interdite aux voitures automobiles



**2.04**  
Verbot für Motorräder  
Circulation interdite aux motocycles



**2.04/06**  
Verbot für Motorräder und Motorfahräder  
Circulation interdite aux motocycles et cyclomoteurs



**2.05**  
Verbot für Fahrräder und Motorfahräder  
Circulation interdite aux cycles et cyclomoteurs



**2.05/06**  
Verbot für Fahrräder und Motorfahräder  
Circulation interdite aux cycles et cyclomoteurs



**2.06**  
Verbot für Motorfahräder  
Circulation interdite aux cyclomoteurs



**2.07**  
Verbot für Lastwagen  
Circulation interdite aux camions



**2.07/08**  
Verbot für Lastwagen und Gesellschaftswagen  
Circulation interdite aux camions et autocars



**2.08**  
Verbot für Gesellschaftswagen  
Circulation interdite aux autocars



**2.09**  
Verbot für Anhänger  
Circulation interdite aux remorques



**2.09.1**  
Verbot für Anhänger mit Ausnahme von Sattel- und Zentralachsanhängern  
Circulation interdite aux remorques; autres que les semi-remorques et les remorques à essien central



**2.10.1**  
Verbot für Fahrzeuge mit gefährlicher Ladung  
Circulation interdite aux véhicules avec chargement dangereux



# Signaltafeln Signaux

## Vorschriftssignale Signaux de prescription



**2.11**  
Verbot für Fahrzeuge mit wassergefährdender Ladung  
*Circulation interdite aux véhicules dont le chargement peut altérer les eaux*



**2.12**  
Verbot für Tiere  
*Circulation interdite aux animaux*



**2.13 (2.13V)**  
Verbot für Motorwagen und Motorräder  
*Circulation interdite aux voitures automobiles et aux motocycles*



**2.14 (2.14V)**  
Verbot für Motorwagen, Motorräder und Motorfahrräder  
*Circulation interdite aux voitures autom., aux motocycles et aux cyclomoteurs*



**2.15**  
Verbot für Fußgänger  
*Accès interdit aux piétons*



**2.15.1**  
Skifahren verboten  
*Interdiction de skier*



**2.15.2**  
Schlitteln verboten  
*Interdiction de luger*



**2.15.3**  
Verbot für fahrzeughähnliche Geräte  
*Accès interdit aux engins assimilés à des véhicules*



**2.15/12**  
Verbot für Fußgänger und Tiere  
*Accès interdit aux piétons et animaux*



**2.16**  
Höchstgewicht (Beispiel)  
*Poids maximal (exemple)*



**2.17**  
Achsdruk (Beispiel)  
*Charge par essieu (exemple)*



**2.18**  
Höchstbreite (Beispiel)  
*Largeur maximale (exemple)*



**2.19**  
Höchsthöhe (Beispiel)  
*Hauteur maximale (exemple)*



**2.20**  
Höchstlänge (Beispiel)  
*Longueur maximale (exemple)*



**2.30 "60"**  
Höchstgeschwindigkeit  
*Vitesse maximale*



**2.30.1**  
Höchstgeschwindigkeit 50 Generell  
*Vitesse maximale 50 limite générale*



**2.30.1F**



**2.30.1I**



**2.30.1R**



**2.31**  
Mindestgeschwindigkeit  
*Vitesse minimale*



**2.32**  
Fahrtrichtung rechts  
*Sens obligatoire à droite*



**2.33**  
Fahrtrichtung links  
*Sens obligatoire à gauche*



**2.34**  
Hindernis rechts umfahren  
*Obstacle à contourner par la droite*



**2.35**  
Hindernis links umfahren  
*Obstacle à contourner par la gauche*



**2.36**  
Geradeausfahren  
*Circuler tout droit*



**2.37**  
Rechtsabbiegen  
*Obliquer à droite*



**2.38**  
Linksabbiegen  
*Obliquer à gauche*



**2.39**  
Rechts- oder Linksabbiegen  
*Obliquer à droite ou à gauche*



**2.40**  
Geradeaus oder Rechtsabbiegen  
*Circuler tout droit ou obliquer à droite*



**2.41**  
Geradeaus oder Linksabbiegen  
*Circuler tout droit ou obliquer à gauche*



**2.41.1**  
Kreisverkehrsplatz  
*carrefour à sens giratoire*



**2.42**  
Abbiegen nach rechts verboten  
*Interdiction d'obliquer à droite*



**2.43**  
Abbiegen nach links verboten  
*Interdiction d'obliquer à gauche*



**2.44**  
Ueberholen verboten  
*Interdiction de dépasser*



**2.45**  
Ueberholen für Lastwagen verboten  
*Interdiction aux camions de dépasser*



**2.46**  
Wenden verboten  
*Interdiction de faire demi-tour*



**2.47**  
Mindestabstand  
*Distance minimale*



**2.48**  
Schneeketten obligatorisch  
*Chaines à neige obligatoires*



**2.49**  
Halten verboten  
*Interdiction de s'arrêter*



**2.50**  
Parkieren verboten  
*Interdiction de parquer*



**2.51**  
Zollhaltestelle  
*Arrêt à proximité de douane*



**2.51I**  
Fermata al posta di dogana  
*Arrêt à proximité de douane*



**2.52**  
Polizei  
*Police*



**2.52I**  
Polizia  
*Police*



**2.53.1**  
Ende der Höchstgeschwindigkeit 50 Generell  
*Fin de la vitesse maximale 50 limite générale*



**2.53.1F**



**2.53.1I**



**2.53.1R**

# Signaltafeln Signaux

## Vorschriftssignale Signaux de prescription



**2.53 "60"**  
Ende der Höchstgeschwindigkeit  
*Fin de la vitesse maximale*



**2.54**  
Ende der Mindestgeschwindigkeit  
*Fin de la vitesse minimale*



**2.55**  
Ende des Ueberholverbotes  
*Fin de l'interdiction de dépasser*



**2.56**  
Ende des Ueberholverbotes für Lastwagen  
*Fin de l'interdiction aux camions de dépasser*



**2.56.1**  
Ende des Teilfahrverbots (Beispiel)  
*Fin de l'interdiction partielle de circuler (exemple)*



**2.57**  
Ende des Schneeketten-Obligatoriums  
*Fin de l'obligation d'utiliser des chaînes à neige*



**2.58**  
Freie Fahrt  
*Libre circulation*



**2.60**  
Radweg  
*Piste cycable*



**2.60.1**  
Ende des Radweges  
*Fin de la piste cycable*



**2.61**  
Fussweg  
*Chemin pour piétons*



**2.62**  
Reitweg  
*Allée d'équitation*



**2.63.1**  
Gemeinsamer Rad- und Fussweg  
*Piste cycable et chemin pour piétons sans partage de l'aire de circulation*



**2.63 LI**  
Rad- und Fussweg mit getrennten Verkehrsflächen  
*Piste cycable et chemin pour piétons avec partage de l'aire de circulation*



**2.63 RE**  
Fuss- und Radweg mit getrennten Verkehrsflächen  
*Piste cycable et chemin pour piétons avec partage de l'aire de circulation*



**2.64**  
Busfahrbahn  
*Chaussée réservée aux bus*

### Weitere Vorschriftssignale: Autres signaux de prescription:

Seite/page

16 18 20



## Vortrittssignal Signal de priorité



**3.09**  
Dem Gegenverkehr Vortritt lassen  
*Laissez passer les véhicules venant en sens inverse*

### Weitere Vortrittssignale: Autres signaux de priorité:

Seite/page

4 6 14 15 16



## Bestellinformationen Informations de commande

Signal Formate (mm)  
*Formats signal (mm)*

400  
 600  
 900\*  
 1200\*

Material, Beschichtung  
*Matériau, revêtement*

AH (Alu, R2)  
AV (Alu, R3)

Preisliste  
*Liste de prix*

**P1-36**

## Verweise/Renvois

Zusatztafeln  
*Plaques complémentaires*

Seite/page **26**

## Rahmen und Ständer Cadres et supports

Signaflex W34F  
(400, 600)

Seite  
page

40

R347J  
Jordahlschienen/glissières "Jordahl"  
(400, 600, 900, 1200)

Seite  
page

49

Signaflex W34FA  
(400, 600)

Seite  
page

40

R541C  
(400, 600)

Seite  
page

51

\* Nur für R347J/Seulement pour "R347J"

# Signaltafeln Signaux

## Vorschriftssignale kombiniert Signaux de prescription combinés

Beispiele  
Exemples

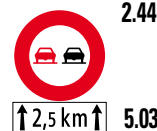

### Bestellinformationen Informations de commande

Signal Formate (mm) Formats signal (mm)	<input type="radio"/>	400 + 400 x 200
	<input type="radio"/>	600 + 600 x 200
	<input type="radio"/>	900 + 900 x 300
	<input type="radio"/>	1200 + 1200 x 400

Material, Beschichtung Matériau, revêtement	AH	(Alu, R2)
	AV	(Alu, R3)

Preisliste Liste de prix	<b>P1-36</b>	+	<b>P1-17</b>
-----------------------------	--------------	---	--------------

### Verweise/Renvois

Zusatztafeln Plaques complémentaires	
Seite/page	<b>26</b>

### Rahmen und Ständer Cadres et supports

	Seite page		Seite page
Signaflex W34F + R348J (400 + 400x200, 600 + 600x200)	<b>40, 50</b>	Signaflex W34F + R349J* (400 + 400x200, 600 + 600x200)	<b>40, 50</b>
Signaflex W35FA (400, 600)	<b>40</b>	R347J + R348J Jordahlschienen/glissières "Jordahl" (400 + 400x200, 600 + 600x200)	<b>49, 50</b>
R347J + R349J* Jordahlschienen/glissières "Jordahl" (400 + 400x200, 600 + 600x200)	<b>49, 50</b>	R347J + R392J Jordahlschienen/glissières "Jordahl" (900 + 900x300, 1200 + 1200x400)	<b>49, 50</b>
R542C (400, 600)	<b>51</b>		

\* günstige Variante zu R348J/Variante à prix réduit par rapport à R348J

Beispiele  
Exemples



### Bestellinformationen Informations de commande

Signal Formate (mm) Formats signal (mm)	<input type="radio"/>	400
	<input type="radio"/>	600
	<input type="radio"/>	900*
	<input type="radio"/>	1200*

Material, Beschichtung Matériau, revêtement	AH	(Alu, R2)
	AV	(Alu, R3)

Preisliste Liste de prix	<b>P1-36</b>
-----------------------------	--------------

### Verweise/Renvois

Zusatztafeln Plaques complémentaires	
Seite/page	<b>26</b>

### Rahmen und Ständer Cadres et supports

	Seite page		Seite page
Signaflex W3434F (400, 600)	<b>40</b>	R347J + R347J Jordahlschienen/glissières "Jordahl" (400, 600, 900, 1200)	<b>49</b>

\* Nur für Jordahl/Seulement pour "Jordahl"

# Signaltafeln Signaux

## Vorschriftssignale kombiniert Signaux de prescription combinés

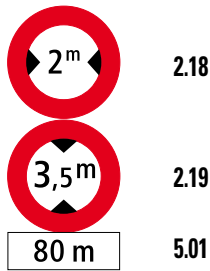

Beispiel  
Exemple

### Bestellinformationen Informations de commande

<b>Signal Formate (mm)</b> <i>Formats signal (mm)</i>	<input type="radio"/> 400 + 400 x 200 <input type="radio"/> 600 + 600 x 200 <input type="radio"/> 900 + 900 x 300 <input type="radio"/> 1200 + 1200 x 400
<b>Material, Beschichtung</b> <i>Matériau, revêtement</i>	AH (Alu, R2) AV (Alu, R3)
<b>Preisliste</b> <i>Liste de prix</i>	<b>P1-36</b> + <b>P1-17</b>
<b>Verweise/Renvois</b>	
<b>Zusatztafeln</b> <i>Plaques complémentaires</i>	 Seite/page <b>26</b>

### Rahmen und Ständer Cadres et supports

	Seite page		Seite page
<b>Signaflex W3434F + R348J</b> (400 + 400x200, 600 + 600x200)	<b>40, 50</b>	<b>Signaflex W3434F + R349J*</b> (400 + 400x200, 600 + 600x200)	<b>40, 50</b>
<b>R347J + R347J + R348J</b> Jordahlschienen/ <i>glissières</i> "Jordahl" (400 + 400x200, 600 + 600x200)	<b>49, 50</b>	<b>R347J + R347J + R349J*</b> Jordahlschienen/ <i>glissières</i> "Jordahl" (400 + 400x200, 600 + 600x200)	<b>49, 50</b>
<b>R347J + R347J + R392J</b> Jordahlschienen/ <i>glissières</i> "Jordahl" (900 + 900x300, 1200 + 1200x400)	<b>49, 50</b>		

\* günstige Variante zu R348J/*Variante à prix réduit par rapport à R348J*

## Vorschriftssignale mit Hinweissignalen kombiniert Signaux de prescription combinés avec signaux d'indication

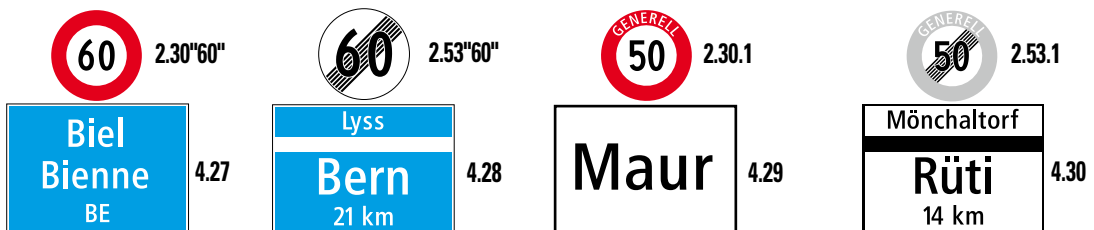

Beispiele  
Exemples

### Bestellinformationen Informations de commande

<b>Signal Formate (mm)</b> <i>Formats signal (mm)</i>	<input type="radio"/> 700 x 500 + <input type="radio"/> 600 <input type="radio"/> 1000 x 700 + <input type="radio"/> 600 (Standard: Radius/ <i>rayon</i> R=30)
<b>Material, Beschichtung</b> <i>Matériau, revêtement</i>	AH (Alu, R2) AV (Alu, R3)
<b>Preisliste</b> <i>Liste de prix</i>	<b>P1-36</b> + <b>P1-73</b>
<b>Verweise / Renvois</b>	
<b>Zusatztafeln</b> <i>Plaques complémentaires</i>	 Seite/page <b>14</b> <b>11</b>

### Rahmen und Ständer Cadres et supports

	Seite page		Seite page
<b>Signaflex R6434F</b> (700x500 + 600, 1000x700 + 600)	<b>43</b>	<b>Signaflex R6434FA</b> (700x500 + 600, 1000x700 + 600)	<b>43</b>
<b>R392J + R347J</b> (700x500 + 600, 1000x700 + 600)	<b>49</b>	<b>R39134C</b> (700x500 + 600, 1000x700 + 600)	<b>52</b>

### Verweise / Renvois

<b>Zusatztafeln</b> <i>Plaques complémentaires</i>	 Seite/page <b>14</b> <b>11</b>
---	------------------------------------

# Signaltafeln Signaux



## Zusatztafeln Plaques complémentaires

Beispiel  
Exemple

21

4.57  
Nummerntafel für  
Hauptstrassen  
Plaque numérotée  
pour routes  
principales



Weitere Ergänzungssignale:  
Autres signaux complémentaires:

Seite/page  
26 28  
 







### Bestellinformationen Informations de commande

Signal Formate (mm) Formats signal (mm)	170 x 210 (1 Zahl/1 chiffre) 250 x 210 (2 Zahlen/2 chiffres)
Material, Beschichtung Matériau, revêtement	AH (Alu, R2) AV (Alu, R3)
Preisliste Liste de prix	<b>P1-79</b> + <b>P1-80</b>

### Befestigungsplatte Plaque de fixation

UBR170*	UBR250*
	
Format = 170 x 210	Format = 250 x 210

### Kombinationen mit Signalträger Combinaisons avec supports de signaux

					
Seite/page 10	10	10	14	14	14
** Sonderausführung = <input type="checkbox"/> Exécution spéciale = <input type="checkbox"/>					

## Zusatztafeln Plaques complémentaires

### Bestellinformationen Informations de commande

Signal Formate (mm) Formats signal (mm)	80 x 240 (für/pour Ø 400) 120 x 360 (für/pour Ø 400 + 600) 180 x 540 (für/pour Ø 900) 240 x 720 (für/pour Ø 1200)
Material, Beschichtung Matériau, revêtement	AH (Alu, R2) AV (Alu, R3)
Preisliste Liste de prix	<b>P1-85</b> + <b>P1-86</b>



5.04  
Wiederholungstafel  
Plaque de rappel



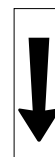

5.05  
Anfangstafel  
Plaque indiquant le début  
d'une prescription





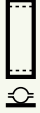
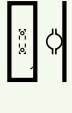

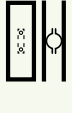



5.06  
Endetafel  
Plaque indiquant la fin  
d'une prescription

### Befestigungsplatten Plaques de fixation

			
V311* (einseitig, mono-face)	V311A* (einseitig, mono-face)	V312* (doppelseitig, double face)	V312A* (doppelseitig, double face)
Format = 80 x 240 Format = 120 x 360 Format = 180 x 540 Format = 240 x 720	Format = 80 x 240 Format = 120 x 360 Format = 180 x 540 Format = 240 x 720	Format = 80 x 240 Format = 120 x 360 Format = 180 x 540 Format = 240 x 720	Format = 80 x 240 Format = 120 x 360 Format = 180 x 540 Format = 240 x 720

### Kombinationen mit Signalträger Combinaisons avec supports de signaux

				
Seite/page 6	6	6	6	
				
Seite/page 10	10	10	10	10
** Sonderausführung = <input type="checkbox"/> Exécution spéciale = <input type="checkbox"/>				



# Signaltafeln Signaux

## Vortrittssignal "Stop" Signal de priorité "Stop"



3.01  
Stop  
Stop

Weitere Vortrittssignale:  
Autres signaux de priorité:

Seite/page

4 6 10 15 17







### Bestellinformationen Informations de commande

Signal Formate (mm) Formats signal (mm)	<input type="radio"/> 500 <input type="radio"/> 600 <input type="radio"/> 900
Material, Beschichtung Matériau, revêtement	AH (Alu, R2) AV (Alu, R3)
Preisliste Liste de prix	<b>P1-54</b>

### Verweise/Renvois

Zusatztafeln Plaques complémentaires	 Seite/page <b>26</b>
---	---

### Rahmen und Ständer Cadres et supports

	Seite page		Seite page
 <b>Signaflex E34F</b> (500, 600)	<b>41</b>	 <b>E347J</b> Jordahlschienen/glissières "Jordahl" (500, 600, 900)	<b>49</b>
 <b>Signaflex E34FA</b> (500, 600)	<b>41</b>	 <b>E541C</b> (500, 600, 900)	<b>51</b>

## Vortrittssignal "Stop" kombiniert Signal de priorité "Stop" combiné

Beispiel  
Exemple



3.01

5.01







### Bestellinformationen Informations de commande

Signal Formate (mm) Formats signal (mm)	<input type="radio"/> 500 + 500 x 200 <input type="radio"/> 600 + 600 x 200 <input type="radio"/> 900 + 900 x 300
Material, Beschichtung Matériau, revêtement	AH (Alu, R2) AV (Alu, R3)
Preisliste Liste de prix	<b>P1-54</b> + <b>P1-17</b>

### Verweise/Renvois

Zusatztafeln Plaques complémentaires	 Seite/page <b>26</b>
---	---

### Rahmen und Ständer Cadres et supports

	Seite page		Seite page
 <b>Signaflex E34F + R348J</b> (500 + 500x200, 600 + 600x200)	<b>41, 50</b>	 <b>Signaflex E34F + R349J*</b> (500 + 500x200, 600 + 600x200)	<b>41, 50</b>
 <b>Signaflex E35FA</b> (500, 600)	<b>42</b>	 <b>E347J + R348J</b> Jordahlschienen/glissières "Jordahl" (500 + 500x200, 600 + 600x200)	<b>49, 50</b>
 <b>E347J + R349J*</b> Jordahlschienen/glissières "Jordahl" (500 + 500x200, 600 + 600x200)	<b>49, 50</b>	 <b>E347J + R392J</b> Jordahlschienen/glissières "Jordahl" (900 + 900x300)	<b>49, 50</b>
 <b>E542C</b> (500, 600)	<b>51</b>		

\* günstige Variante zu R348J/Variante à prix réduit par rapport à R348J

# Signaltafeln Signaux

## Vortrittssignale Signaux de priorité



**3.03**  
Hauptstrasse  
Route principale



**3.04**  
Ende der Hauptstrasse  
Fin de la route principale

### Bestellinformationen Informations de commande

Signal Formate (mm) Formats signal (mm)	◇ 350
	◇ 500
	◇ 700
	◇ 900
(Standard: Radius/rayon R=30)	

Material, Beschichtung Matériau, revêtement	AH (Alu, R2)
	AV (Alu, R3)

Preisliste Liste de prix	<b>P1-64</b>
-----------------------------	--------------

### Verweise/Renvois

Zusatztafeln Plaques complémentaires	  Seite/page <b>28</b>
---	------------------------------

## Vortrittssignale kombiniert Signaux de priorité combinés

Beispiel  
Exemple



**3.03**

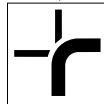

**5.09**  
Richtung der Hauptstrasse  
Direction de la route principale

### Bestellinformationen Informations de commande

Signal Formate (mm) Formats signal (mm)	◇ 350 + 500 x 500
	◇ 500 + 600 x 600
	(Standard: Radius/rayon R=30)

Material, Beschichtung Matériau, revêtement	AH (Alu, R2)
	AV (Alu, R3)

Preisliste Liste de prix	<b>P1-64</b> + <b>P1-19</b>
-----------------------------	-----------------------------

### Verweise/Renvois

Zusatztafeln Plaques complémentaires	  Seite/page <b>28</b>
---	------------------------------

### Rahmen und Ständer Cadres et supports

	Seite page		Seite page
<b>Signaflex R50F</b> (350, 500, 700)	<b>42</b>	<b>R582J</b> Jordahlschienen/glissières "Jordahl" (350, 500, 700, 900)	<b>49</b>
<b>Signaflex R50FA</b> (350, 500, 700)	<b>42</b>	<b>R581C</b> (350, 500, 700)	<b>51</b>

### Rahmen und Ständer Cadres et supports

	Seite page		Seite page
<b>Signaflex R50F + R362J</b> (350 + 500x500, 500 + 600x600)	<b>42, 49</b>	<b>Signaflex R5350FA</b> (350, 500)	<b>42</b>
<b>R582J + R362J</b> Jordahlschienen/glissières "Jordahl" (350 + 500x500, 500 + 600x600)	<b>49</b>	<b>R36150C</b> (350, 500)	<b>51</b>

# Signaltafeln Signaux

## Vorschriftssignale Signaux de prescription



**2.59.5Z**  
Begegnungszone  
*Zone de rencontre*

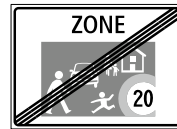

**2.59.6Z**  
Ende der Begegnungszone  
*Fin de la zone de rencontre*

### Weitere Vorschriftssignale: Autres signaux de prescription:

Seite/page



## Hinweissignale Signaux d'indication



**4.27**  
Ortsbeginn auf  
Hauptstrassen  
*Début de localité sur  
route principale*

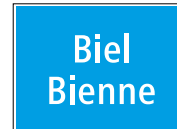

**4.27**  
Ortsbeginn auf  
Hauptstrassen  
*Début de localité sur  
route principale*



**4.27**  
Ortsbeginn auf  
Hauptstrassen  
*Début de localité sur  
route principale*



**4.28**  
Ortsende auf  
Hauptstrassen  
*Fin de localité sur  
route principale*



**4.29**  
Ortsbeginn auf Ne-  
benstrassen  
*Début de localité sur  
routes secondaires*



**4.30**  
Ortsende auf Ne-  
benstrassen  
*Fin de localité sur  
routes secondaires*

### Weitere Hinweissignale: Autres signaux d'indication:

Seite/page

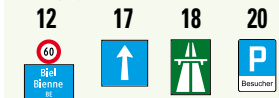

## Bestellinformationen Informations de commande

<b>Signal Formate (mm)</b> <i>Formats signal (mm)</i>	500 x 350 700 x 500 1000 x 700  (Standard: Radius/rayon R=30)
<b>Material, Beschichtung</b> <i>Matériau, revêtement</i>	AH (Alu, R2) AV (Alu, R3)
<b>Preisliste</b> <i>Liste de prix</i>	<b>P1-73</b>

## Rahmen und Ständer Cadres et supports

	Seite page		Seite page
<b>Signaflex R64F</b> (500x350, 700x500, 1000x700)	<b>43</b>	<b>R392J</b> Jordahlschienen/glisières "Jordahl" (500x350, 700x500, 1000x700)	<b>51</b>
<b>Signaflex R64FA</b> (500x350, 700x500, 1000x700)	<b>43</b>	<b>R391C</b> (500x350, 700x500, 1000x700)	<b>52</b>

## Verweise/Renvois

<b>Zusatztafeln</b> <i>Plaques complémentaires</i>	
Seite/page	<b>8</b> <b>11</b>

# Signaltafeln Signaux

## Vortrittssignale Signaux de priorité



**3.10**  
Vortritt vor dem  
Gegenverkehr  
*Priorité par rapport  
aux véhicules venant  
en sens inverse*

Weitere Vortrittssignale:  
Autres signaux de priorité:

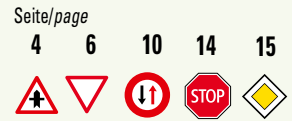

## Hinweissignale Signaux d'indication



**4.05**  
Bergpoststrasse  
*Route postale de mon-  
tagne*



**4.06**  
Ende der Bergpost-  
strasse  
*Fin de la route  
postale de montagne*



**4.08**  
Einbahnstrasse  
*Sens unique*



**4.09**  
Sackgasse  
*Impasse*



**4.09.1**  
Sackgasse  
mit Ausnahme  
*Impasse  
avec exception*



**4.14**  
Spital  
*Hôpital*



**4.17**  
Parkieren gestattet  
*Parcage autorisé*



**4.21**  
Parkhaus  
*Parking couvert*



**4.25P**  
Parkplatz mit Anschluss  
an öffentliches  
Verkehrsmittel  
*Parking avec accès aux  
transports publics*



**4.25PH**  
Parkhaus mit An-  
schluss an öffentli-  
ches Verkehrsmittel  
*Parking couvert avec  
accès aux transports  
publics*

## Bestellinformationen Informations de commande

Signal Formate (mm) Formats signal (mm)	<input type="checkbox"/> 350
	<input type="checkbox"/> 500
	<input type="checkbox"/> 700
	<input type="checkbox"/> 900
(Standard: Radius/rayon R=30)	

Material, Beschichtung Matériau, revêtement	AS (Alu, R1)
	AH (Alu, R2)
	AV (Alu, R3)

Preisliste  
Liste de prix **P1-64**

## Rahmen und Ständer Cadres et supports

	Seite page		Seite page
<b>Signaflex R53F</b> (350, 500, 700)	<b>44</b>	<b>R362J</b> Jordahlschienen/glisières "Jordahl" (350, 500, 700, 900)	<b>49</b>
<b>Signaflex R53FA</b> (350, 500, 700)	<b>44</b>	<b>R361C</b> (350, 500, 700, 900)	<b>52</b>

# Signaltafeln Signaux

## Vorschriftssignale Signaux de prescription



**2.59.1Z30**  
Zonensignal  
Signal de zone

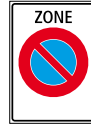

**2.59.1Z2.50**  
Zonensignal  
Signal de zone



**2.59.1**  
Zonensignal  
(Beispiel)  
Signal de zone  
(exemple)



**2.59.3Z**  
Fußgängerzone  
Zone piétonne



**2.59.2Z30**  
Ende Zonensignal  
Signal de fin de zone



**2.59.2Z2.50**  
Ende Zonensignal  
Signal de fin de zone



**2.59.2**  
Ende Zonensignal  
(Beispiel)  
Signal de fin de zone  
(exemple)



**2.59.4Z**  
Ende der  
Fußgängerzone  
Fin de la zone  
piétonne

## Hinweissignale Signaux d'indication



**4.01**  
Autobahn  
Autoroute



**4.02**  
Ende der Autobahn  
Fin de l'autoroute



**4.03**  
Autostrasse  
Semi-autoroute



**4.04**  
Ende der  
Autostrasse  
Fin de la semi-  
autoroute

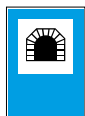

**4.07**  
Tunnel  
Tunnel

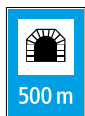

**4.07A**  
Tunnel (Vorsignal  
auf Autobahn)  
Tunnel (Signal  
avancé sur les  
autoroutes)



**4.08.1**  
Einbahnstrasse mit  
Gegenverkehr von  
Radfahrern (Bsp.)  
Sens unique avec  
circulation de cyclistes  
en sens inverse (exemple)



**4.10**  
Wasserschutzgebiet  
(Beispiel)  
Zone de protection  
des eaux (exemple)



**4.11L**  
Fußgängerstreifen  
(linksgehend)  
Passage pour  
piétons (à gauche)



**4.11R**  
Fußgängerstreifen  
(rechtsgehend)  
Passage pour  
piétons (à droite)



**4.12L**  
Fußgängerunter-  
führung linksge-  
hend  
Passage souter-  
rain pour piétons  
à gauche



**4.12R**  
Fußgängerunter-  
führung rechts-  
gehend  
Passage souter-  
rain pour piétons  
à droite



**4.13L**  
Fußgängerüber-  
führung linksge-  
hend  
Passerelle pour  
piétons à gauche



**4.13R**  
Fußgängerüber-  
führung rechts-  
gehend  
Passerelle pour  
piétons à droite



**4.15**  
Ausstellplatz  
Place  
d'évitement



**4.16**  
Abstellplatz für  
Pannenfahrzeuge  
Place d'arrêt  
pour véhicules en  
panne



**4.18**  
Parkieren mit  
Parkscheibe  
Parcage avec  
disque de  
stationnement

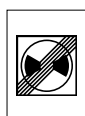

**4.19**  
Ende des Parkierens  
mit Parkscheibe  
Fin du parcage avec  
disque de  
stationnement



**4.20**  
Parkieren gegen  
Gebühr  
Parcage contre  
paiement



**4.22**  
Entfernung und  
Richtung eines  
Parkplatzes  
Distance et  
direction d'un  
parking



**4.23**  
Vorwegweiser für  
bestimmte Fahr-  
zeugarten (Beispiel  
Lastwagen)  
Indicateur de  
direction avancé  
pour des genres de  
véhicules déterminés  
(exemple camions)



**4.24**  
Notfallspur  
Voie de détresse



# Signaltafeln Signaux

## Hinweissignale Signaux d'indication

<b>4.25PS (9.01)</b> Parkplatz mit Anschluss an Bahn <i>Parking avec accès au train</i>	<b>4.25PS (9.01c)</b> Parkplatz mit Anschluss an Tram <i>Parking avec accès au tram</i>	<b>4.25PS (9.02)</b> Parkhaus mit Anschluss an Bus <i>Parking couvert avec accès au bus</i>	<b>4.25PHS (9.01)</b> Parkhaus mit Anschluss an Bahn <i>Parking couvert avec accès au train</i>	<b>4.25PHS (9.01c)</b> Parkhaus mit Anschluss an Tram <i>Parking couvert avec accès au tram</i>	<b>4.25PHS (9.02)</b> Parkhaus mit Anschluss an Bus <i>Parking couvert avec accès au bus</i>	<b>4.25PHS (9.01)</b> Parkhaus mit Anschluss an Bahn <i>Parking couvert avec accès au train</i>
<b>4.79</b> Zeltplatz <i>Place de camping</i>	<b>4.80</b> Wohnwagenplatz <i>Terrain pour caravanes</i>	<b>4.81</b> Telefon <i>Téléphone</i>	<b>4.82</b> Erste Hilfe <i>Premiers secours</i>	<b>4.79</b> Zeltplatz <i>Place de camping</i>	<b>4.80</b> Wohnwagenplatz <i>Terrain pour caravanes</i>	<b>4.81</b> Telefon <i>Téléphone</i>
<b>4.83</b> Pannenhilfe <i>Poste de dépannage</i>	<b>4.84</b> Tankstelle <i>Poste d'essence</i>	<b>4.85</b> Hotel-Motel <i>Hôtel-Motel</i>	<b>4.86</b> Restaurant <i>Restaurant</i>	<b>4.87</b> Erfrischungen <i>Rafraîchissements</i>	<b>4.88</b> Informationsstelle <i>Poste d'information</i>	<b>4.83</b> Pannenhilfe <i>Poste de dépannage</i>
<b>4.89</b> Jugendherberge <i>Auberge de jeunesse</i>	<b>4.90</b> Radio-Verkehrsinformation <i>Bulletin routier radiophonique</i>	<b>4.91</b> <sup>*</sup> Gottesdienst <i>Service religieux</i>	<b>4.89</b> Jugendherberge <i>Auberge de jeunesse</i>	<b>4.90</b> Radio-Verkehrsinformation <i>Bulletin routier radiophonique</i>	<b>4.91</b> <sup>*</sup> Gottesdienst <i>Service religieux</i>	<b>4.89</b> Jugendherberge <i>Auberge de jeunesse</i>

**Weitere Hinweissignale:**  
**Autres signaux d'indication:**

Seite/page

16	17	20
Bern	↑	Besuchter

## Bestellinformationen Informations de commande

<b>Signal Formate (mm)</b> <b>Formats signal (mm)</b>	350 x 500 500 x 700 660 x 1000* 700 x 1000 900 x 1250 <small>(Standard: Radius/rayon R=30)</small>
<b>Material, Beschichtung</b> <b>Matériau, revêtement</b>	AS (Alu, R1) AH (Alu, R2) AV (Alu, R3)
<b>Preisliste</b> <b>Liste de prix</b>	<b>P1-93</b>

\* Format 660x1000 ausschliesslich erhältlich für Signal 4.91 (Gottesdienst)  
*Format 660x1000 uniquement disponible pour signal 4.91 (Service religieux)*

## Rahmen und Ständer Cadres et supports

	Seite page		Seite page
	<b>45</b>		<b>45</b>
<b>Signaflex R54F</b> (350x500, 500x700, 700x1000)		<b>Signaflex R54GF</b> <sup>*</sup> (660x1000)	
	<b>45</b>		<b>49</b>
<b>Signaflex R54FA</b> (350x500, 500x700, 700x1000)		<b>R382J</b> Jordahlschienen/glisières "Jordahl" (350x500, 500x700, 700x1000, 900x1250)	
	<b>52</b>		
<b>R381C</b> (350x500, 500x700, 700x1000, 900x1250)			

# Signaltafeln Signaux

## Vorschrifts- und Hinweis- signale kombiniert Signaux de prescription et d'indication combinés

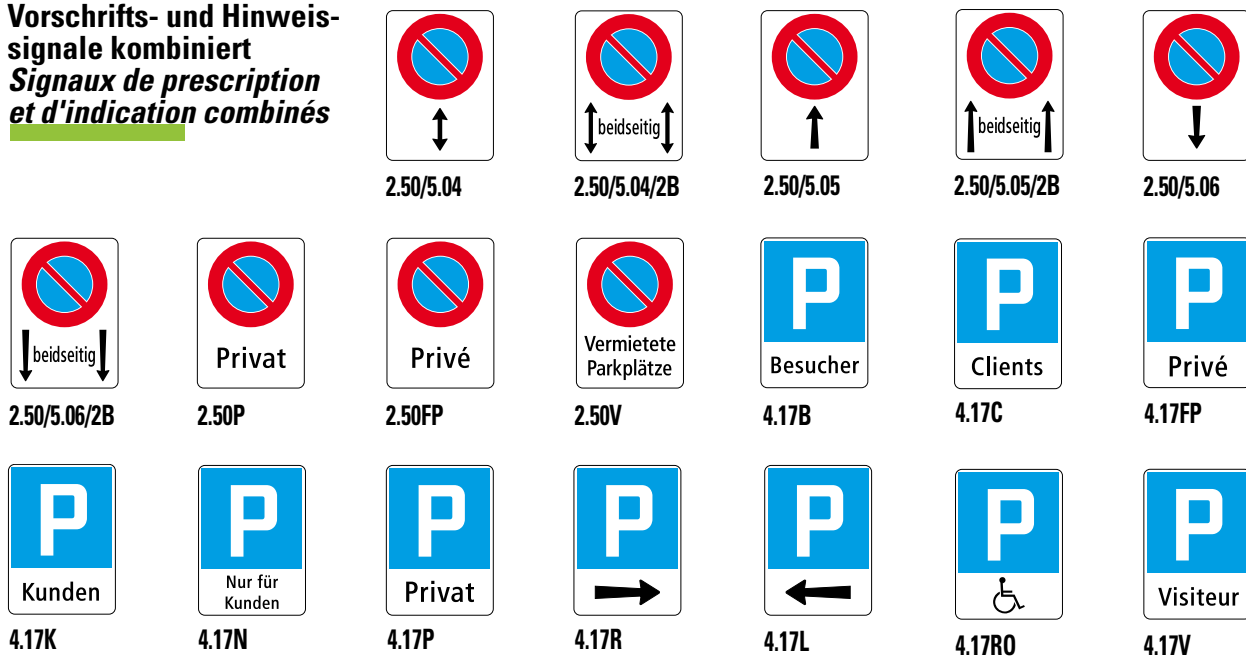

### Beispiele (z.B. 2.01KOMB)/Exemples (p.ex. 2.01KOMB)



### Weitere Hinweissignale: Autres signaux d'indication:

Seite/page	16	17	18
	Bern	↑	⚠

### Bestellinformationen Informations de commande

Signal Formate (mm) Formats signal (mm)	350 x 500 426 x 750 500 x 700 700 x 1000 (Standard: Radius/rayon R=30)
--	--

Material, Beschichtung Matériau, revêtement	AS (Alu, R1) AH (Alu, R2) AV (Alu, R3)
--	--

Preisliste Liste de prix	<b>P1-94</b>
-----------------------------	--------------

### Verweise/Renvois

Zusatztafeln Plaques complémentaires	Seite/page 26
---	---------------

### Rahmen und Ständer Cadres et supports

	Seite page		Seite page
Signaflex R54F (350x500, 426x750, 500x700, 700x1000)	45	R382J Jordahlschienen/gliissières "Jordahl" (350x500, 426x750, 500x700, 700x1000)	49
Signaflex R54FA (350x500, 426x750, 500x700, 700x1000)	45	R381C (350x500, 426x750, 500x700, 700x1000)	52

\* Kombitafel mit integriertem Wechselrahmen siehe Kapitel 6 - Informationssysteme  
Signal combiné avec panneau interchangeable voir chapitre 6 - Systèmes d'informations

# Signaltafeln Signaux

## Wegweisung Indication de direction

### Beispiele Exemples



**4.31**  
Wegweiser zu Autobahnen oder Autostrassen  
*Indicateur de direction pour autoroutes et semi-autoroutes*



**4.32**  
Wegweiser für Hauptstrassen  
*Indicateur de direction pour routes principales*



**4.32**  
Wegweiser für Hauptstrassen (2 Zeilen)  
*Indicateur de direction pour routes principales (2 lignes)*



**4.33**  
Wegweiser für Nebenstrassen  
*Indicateur de direction pour routes secondaires*



**4.34**  
Wegweiser bei Umleitungen  
*Indicateur de direction pour déviations*



**4.34.1**  
Wegweiser für Umleitungen ohne Zielangabe  
*Indicateur de direction pour déviations sans mention du lieu de destination*



**4.45**  
Wegweiser "Schwerverkehr"  
(Beispiel)  
*Indicateur de direction "Poids lourds" (exemple)*



**4.46**  
Wegweiser "Parkplatz" ohne Distanzangabe  
*Indicateur de direction "Parking" sans indication de la distance*

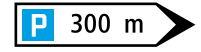

**4.46**  
Wegweiser "Parkplatz" mit Distanzangabe  
*Indicateur de direction "Parking" avec indication de la distance*

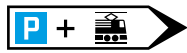

**4.46.1**  
Wegweiser "Parkplatz mit Anschluss an öffentliches Verkehrsmittel"  
(Beispiel)  
*Indicateur de direction "Parking avec accès aux transports publics" (exemple)*



**4.47**  
Wegweiser "Zeltplatz"  
*Indicateur de direction "Place de camping"*



**4.48**  
Wegweiser "Wohnwagenplatz"  
*Indicateur de direction "Terrain pour caravanes"*

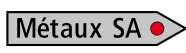

**4.49\***  
Betriebswegweiser  
*Indicateur de direction "Entreprise"*

### Beispiele Exemples



4.31



4.32

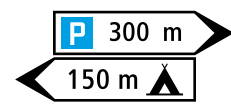

4.46

4.47



4.34



4.45

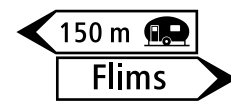

4.48

4.33

### Bestellinformationen Informations de commande

Signal Formate (mm) Formats signal (mm)	1020 x 200	1600 x 200
	1020 x 250	1600 x 250
	1020 x 450	1600 x 300
		1600 x 350
	1300 x 200	1600 x 450
	1300 x 250	1600 x 550
	1300 x 300	1600 x 650
	1300 x 350	
	1300 x 450	1900 x 300
	1300 x 550	1900 x 350
	1300 x 650	1900 x 450
		1900 x 550
		1900 x 650

(Standard: Radius/rayon R=30)

### Beschriftung, Richtung Inscription, direction

ES = Einseitig/*mono-face*  
DS = Beidseitig/*double face*  
Bei DS wird 1 x L und 1 x R geliefert/  
Le DS est livré 1 x gauche et 1 x droite

= R = L

### Material, Beschichtung Matériau, revêtement

AS (Alu, R1)  
AH (Alu, R2)  
AV (Alu, R3)  
ALC\* (Alu einbrennlackiert, Cal Folie/  
Verni au four, feuille Cal)

### Preisliste Liste de prix

**P1-102**

### Rahmen und Ständer Cadres et supports

	Seite page		Seite page
<b>Signiflex R71F</b> (alle Formate bis 1600x650)/ tous les formats jusqu' à 1600x650)	46	<b>R79J</b> (alle Formate/tous les formats)	50
<b>R78C</b> (alle Formate bis 1600x650)/ tous les formats jusqu' à 1600x650)	52	<b>R80C</b> (alle Formate bis 1600x650)/ tous les formats jusqu' à 1600x650)	52
<b>Signiflex R271F</b> (1020x200, 1020x250, 1300x200, 1300x250, 1300x300, 1300x350)	46	<b>Signiflex R276F</b> (1020x200, 1020x250, 1300x200, 1300x250, 1300x300, 1300x350)	46

# Signaltafeln Signaux

## Wegweisung Indication de direction

### Beispiele Exemples

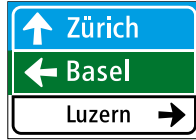

**4.35**  
Wegweiser in Tabellenform  
*Indicateur de direction en forme de tableau*

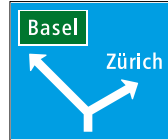

**4.36**  
Vorwegweiser auf Hauptstrassen  
*Indicateur de direction avancé sur routes principales*

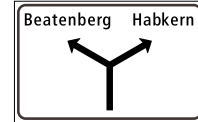

**4.37**  
Vorwegweiser auf Nebenstrassen  
*Indicateur de direction avancé sur routes secondaires*

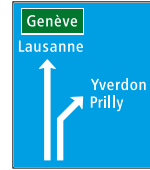

**4.38**  
Vorwegweiser mit Fahrstreifenaufteilung auf Hauptstrassen  
*Indicateur de direction avancé avec répartition des voies sur routes principales*

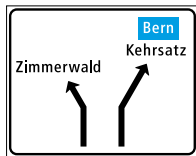

**4.39**  
Vorwegweiser mit Fahrstreifenaufteilung auf Nebenstrassen  
*Indicateur de direction avancé avec répartition des voies sur routes secondaires*

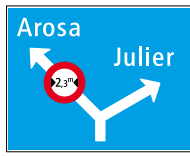

**4.40**  
Vorwegweiser mit Anzeige von Beschränkungen  
*Indicateur de direction avancé annonçant des restrictions*



**4.41**  
Einspurtafel über Fahrstreifen auf Hauptstrassen  
*Panneau de présélection au-dessus d'une voie de circulation sur routes principales*



**4.42**  
Einspurtafel über Fahrstreifen auf Nebenstrassen  
*Panneau de présélection au-dessus d'une voie de circulation sur routes secondaires*

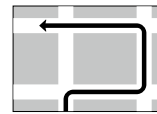

**4.52**  
Verkehrsführung  
*Guidage du trafic*

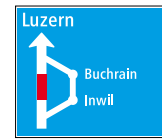

**4.53**  
Vorwegweiser für Umleitungen  
*Indicateur de direction avancé annonçant une déviation*

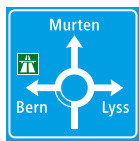

**4.54**  
Vorwegweiser bei Kreisverkehrsplatz (Bsp.)  
*Indicateur de direction avancé annonçant un carrefour à sens giratoire (ex.)*

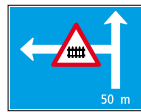

**4.55**  
Abzweigende Strasse mit Gefahrenstelle oder Verkehrsbeschränkung  
*Route latérale présentant un danger ou une restriction*



**4.56**  
Nummerntafel für Europastrassen  
*Plaque numérotée pour routes européennes*



**4.57**  
Nummerntafel für Hauptstrassen  
*Plaque numérotée pour routes principales*



**4.58**  
Nummerntafel für Autobahnen/-strassen  
*Plaque numérotée pour autoroutes/semi-autoroutes*



**4.59**  
Nummerntafel für Anschlüsse (Bsp.)  
*Plaque numérotée pour jonctions (ex.)*



**4.59.1**  
Nummerntafel für Verzweigungen (Bsp.)  
*Plaque numérotée pour ramifications (ex.)*



**4.60**  
Ankündigung des nächsten Anschlusses  
*Panneau annonçant la prochaine jonction*



**4.61**  
Vorwegweiser bei Anschlüssen  
*Indicateur de direction avancé, destiné aux jonctions*



**4.62**  
Wegweiser bei Anschlüssen  
*Indicateur de direction avancé, destiné aux jonctions*



**4.63**  
Ausfahrtstafel  
*Panneau indicateur de sortie*



**4.63 F**  
Ausfahrtstafel  
*Panneau indicateur de sortie*



**4.63 I**  
Ausfahrtstafel  
*Panneau indicateur de sortie*



**4.64**  
Trennungstafel  
*Panneau de bifurcation*

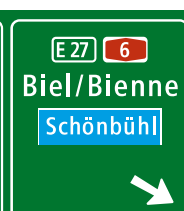

**4.65**  
Entfernungstafel  
*Panneau des distances*

## Wegweisung Indication de direction



**4.66**  
Verzweigungstafel  
Panneau de  
ramification

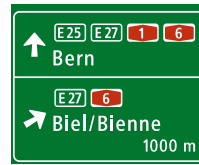

**4.67**  
Erster Vorwegweiser bei  
Verzweigungen  
Premier indicateur de  
direction avancé, destiné  
aux ramifications



**4.68**  
Zweiter Vorwegweiser bei  
Verzweigungen  
Deuxième indicateur de  
direction avancé, destiné  
aux ramifications



**4.69**  
Einspurtafel über Fahrstreifen  
auf Autobahnen und  
Autostrassen  
Panneau de présélection  
au-dessus d'une voie de  
circulation sur autoroutes  
et semi-autoroutes



**4.70 150**  
Hinweis auf Notrufsäulen  
Plaque indiquant un  
téléphone de secours



**4.71**  
Hinweis auf Polizeistütz-  
punkte

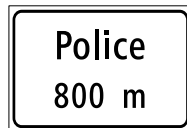

**4.71 F**  
Panneau indiquant un  
centre de police



**4.71 I**  
Cartello indicante un  
centro di polizia

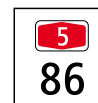

**4.72**  
Kilometertafel  
Plaque indiquant le  
nombre de kilomètres

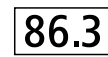

**4.73**  
Hektometertafel  
Plaque indiquant le  
nombre d'hectomètres



**4.75**  
Strassenzustand  
Etat de la route



**4.76**  
Vororientierung über den  
Strassenzustand  
Préavis sur l'état de la  
route

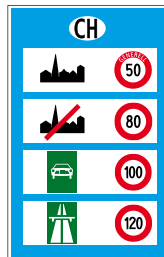

**4.93**  
Anzeige der allgemeinen  
Höchstgeschwindigkeiten  
Information sur les limita-  
tions générales de vitesse



**4.RA**  
Ankündigung einer  
Raststätte  
Panneau annonçant  
une aire de ravitaillement



**4.AR**  
Ankündigung eines  
Rastplatzes  
Panneau annonçant  
une aire de repos

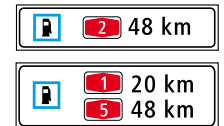

**4.AT**  
Ankündigung  
übernächste Tankstelle  
Annonce du poste  
d'essence suivant

## Bestellinformationen Informations de commande

Signal Formate (mm)  
Formats signal (mm)



## Rahmen und Ständer Cadres et supports

Seite  
page

Seite  
page

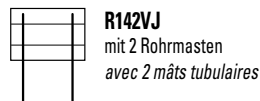

**R142VJ**  
mit 2 Rohrmasten  
avec 2 mâts tubulaires

**50**

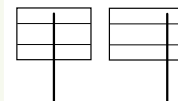

**R142VJ**  
mit 1 Rohrmast  
avec 1 mât  
tubulaire

**50**

## Verweise/Renvois

Zusatztafeln  
Plaques complémentaires

Seite/page



**26**

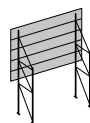

**Alu-Profilbauweise:** siehe Kapitel 7, HLS  
**Profils d'aluminium:** voir chapitre 7, RGD



# Signaltafeln Signaux

## Anzeige der Fahrstreifen (Beispiele) Disposition des voies de circulation (exemples)

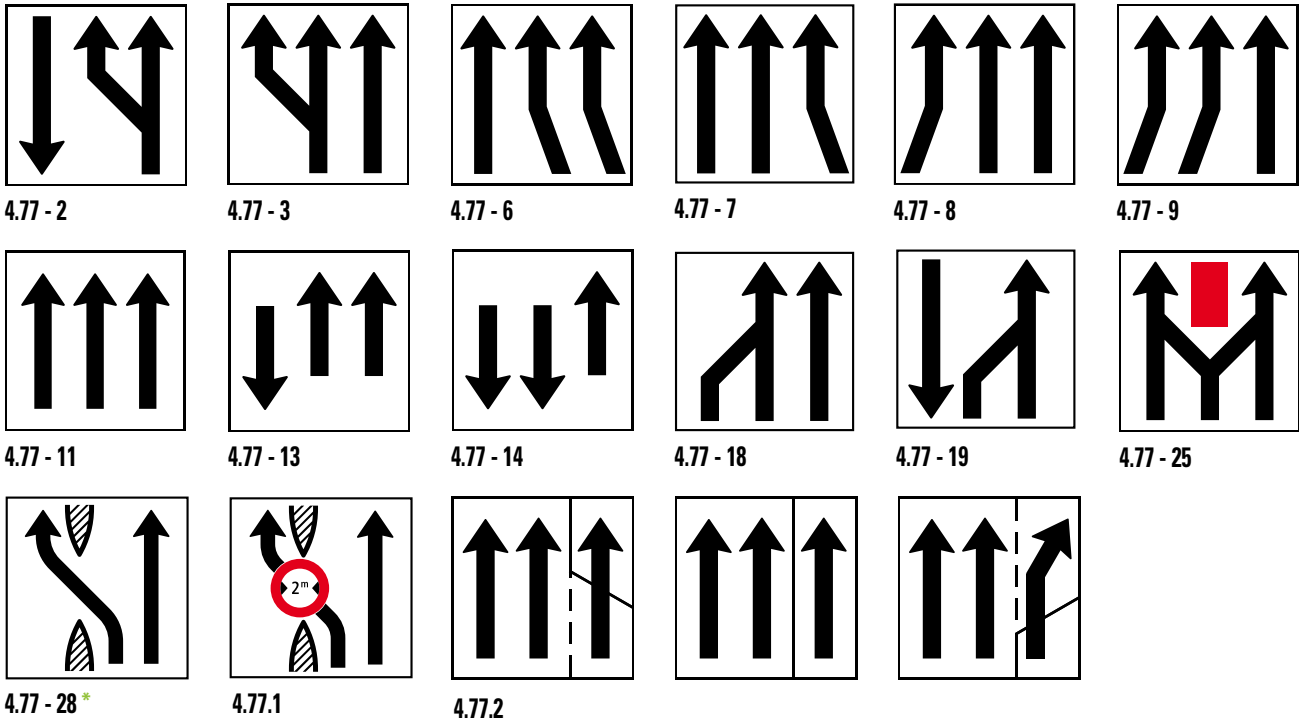

### Bestellinformationen Informations de commande

Signal Formate (mm) Formats signal (mm)	<input type="checkbox"/> 700 <input type="checkbox"/> 900* <input type="checkbox"/> 1000 <input type="checkbox"/> 1250 <input type="checkbox"/> 1500*
--	---

Material, Beschichtung Matériau, revêtement	AH (Alu, R2) AV (Alu, R3)
--	------------------------------

Preisliste Liste de prix	<b>P1-114</b>
-----------------------------	---------------

### Rahmen und Ständer Cadres et supports

R362J Jordahlschienen/glissières "Jordahl" (alle Formate/tous les formats)	Seite page	49
--	---------------	----

R142VJ = <input type="checkbox"/> mit 1 Rohrmast avec 1 mât tubulaire	Seite page	50
---	---------------	----

\* Formate 900 und 1500 nur erhältlich für Signal 4.77 - 28  
Formats 900 et 1500 uniquement disponibles pour signal 4.77 - 28

## Anzeige der Fahrstreifen Disposition des voies de circulation

Beispiel  
Exemple

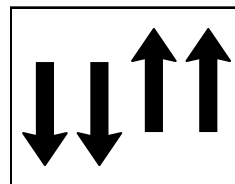

4.77 - 15  
Anzeige der Fahrstreifen  
Disposition des voies de circulation

### Bestellinformationen Informations de commande

Signal Formate (mm) Formats signal (mm)	900 x 700 1250 x 1000 1700 x 1250
--	---

Material, Beschichtung Matériau, revêtement	AH (Alu, R2) AV (Alu, R3)
--	------------------------------

Preisliste Liste de prix	<b>P1-116</b>
-----------------------------	---------------

### Rahmen und Ständer Cadres et supports

R392J Jordahlschienen/glissières "Jordahl" (900x700, 1250x1000)	Seite page	49
---	---------------	----

R142VJ = <input type="checkbox"/> mit 1 Rohrmast avec 1 mât tubulaire	Seite page	50
---	---------------	----

## Anzeige der Fahrstreifen (Beispiele) Disposition des voies de circulation (exemples)

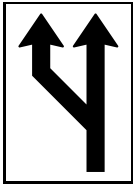

**4.77 - 1**  
Format = 500 x 700  
Format = 700 x 1000  
Format = 900 x 1250

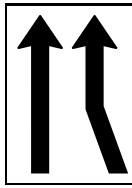

**4.77 - 4**  
Format = 500 x 700  
Format = 700 x 1000  
Format = 900 x 1250

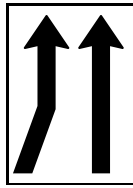

**4.77 - 5**  
Format = 500 x 700  
Format = 700 x 1000  
Format = 900 x 1250

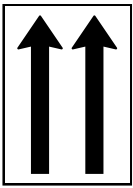

**4.77 - 10**  
Format = 500 x 700  
Format = 700 x 1000  
Format = 900 x 1250

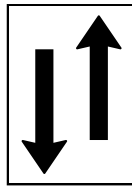

**4.77 - 12**  
Format = 500 x 700  
Format = 700 x 1000  
Format = 900 x 1250

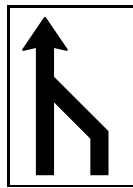

**4.77 - 16**  
Format = 500 x 700  
Format = 700 x 1000  
Format = 900 x 1250

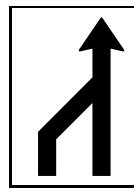

**4.77 - 17**  
Format = 500 x 700  
Format = 700 x 1000  
Format = 900 x 1250

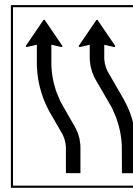

**4.77 - 20**  
Format = 700 x 900  
Format = 1000 x 1250  
Format = 1250 x 1500

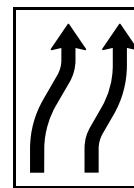

**4.77 - 21**  
Format = 700 x 900  
Format = 1000 x 1250  
Format = 1250 x 1500

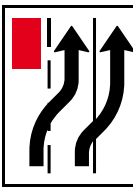

**4.77 - 24**  
Format = 700 x 900  
Format = 1000 x 1250  
Format = 1250 x 1500

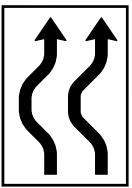

**4.77 - 22**  
Format = 700 x 1000  
Format = 1000 x 1250  
Format = 1250 x 1500

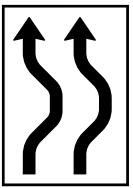

**4.77 - 23**  
Format = 700 x 1000  
Format = 1000 x 1250  
Format = 1250 x 1500

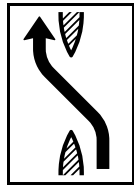

**4.77 - 26**  
Format = 700 x 1000  
Format = 900 x 1250  
Format = 1100 x 1500

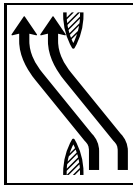

**4.77 - 27**  
Format = 1100 x 1250  
Format = 1500 x 1750  
Format = 1800 x 2100

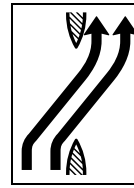

**4.77 - 29**  
Format = 1100 x 1250  
Format = 1500 x 1750  
Format = 1800 x 2100

### Bestellinformationen Informations de commande

<b>Signal Formate (mm)</b> <b>Formats signal (mm)</b>	500 x 700 * 700 x 900 * 700 x 1000 * 900 x 1250 * 1000 x 1250 * 1100 x 1250 * 1100 x 1500 * 1250 x 1500 * 1500 x 1750 * 1800 x 2100 *
--	--

<b>Material, Beschichtung</b> <b>Matériau, revêtement</b>	AH (Alu, R2) AV (Alu, R3)
--	------------------------------

<b>Preisliste</b> <b>Liste de prix</b>	<b>P1-127</b>
---	---------------

### Rahmen und Ständer Cadres et supports

 <b>R382J</b> Jordahlschienen/gliissières "Jordahl" (500x700, 700x1000, 900x1250)	<b>49</b>
--	-----------

Seite  
page

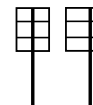









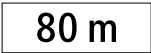

<b>R142VJ = □</b> mit 1 Rohrmast avec 1 mât tubulaire	<b>50</b>
---	-----------

Seite  
page

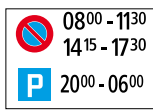
\* erhältlich Formate siehe oben  
dimensions disponibles voir en haut

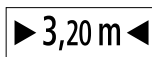

# Signaltafeln Signaux

## Zusatztafeln Plaques complémentaires















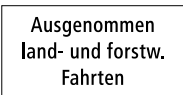
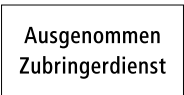
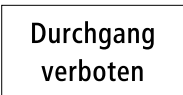

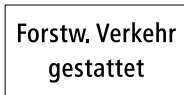
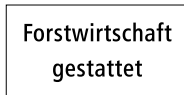

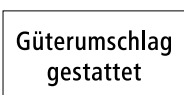

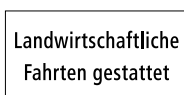
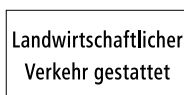
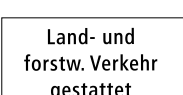
 <b>5.01</b> Distanztafel <i>Plaque de distance</i>	 <b>5.02</b> Richtungstafel mit Distanzangabe <i>Plaque indiquant la distance et la direction</i>	 <b>5.03</b> Streckenlänge <i>Longueur du tronçon</i>	 <b>5.04</b> Wiederholungstafel <i>Plaque de rappel</i>	 <b>5.07</b> Richtungstafel <i>Plaque de direction</i>	 <b>5.10</b> Ausnahmen vom Halteverbot <i>Déroptions à l'interdiction de s'arrêter</i>
 <b>5.11</b> Ausnahme vom Parkierverbot <i>Dérégation à l'interdiction de parquer</i>	 <b>5.12</b> Blinklicht <i>Feux clignotants</i>	 <b>5.13</b> Vereiste Fahrbahn <i>Chaussée verglacée</i>	 <b>5.14</b> Gehbehinderte <i>Handicapés</i>	 <b>5.15</b> Fahrbahnbreite <i>Largeur de la chaussée</i>	 <b>5.18</b> Rechtsabbiegen für Radfahrer gestattet <i>Autorisation d'obliquer à droite pour les cyclistes</i>

**Weitere Ergänzungssignale:**  
**Autres signaux complémentaires:**

Seite/page

13	13	28
		

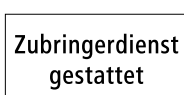
### Standardtexte (Beispiele): Textes standards (exemples):

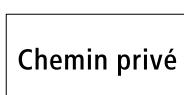
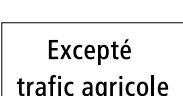
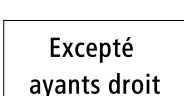
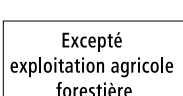
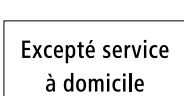



		 <b>5.A1</b>	 <b>5.A2</b>	 <b>5.A9</b>	 <b>5.A10</b>
 <b>5.A14</b>	 <b>5.A19</b>	 <b>5.D1</b>	 <b>5.E2</b>	 <b>5.F9</b>	 <b>5.F10</b>
 <b>5.G1</b>	 <b>5.G2</b>	 <b>5.G4</b>	 <b>5.K1</b>	 <b>5.L1</b>	 <b>5.L3</b>
 <b>5.L5</b>	 <b>5.L6</b>	 <b>5.P1</b>	 <b>5.P2</b>	 <b>5.P3</b>	 <b>5.R4</b>
 <b>5.S1</b>	 <b>5.W2</b>	 <b>5.W5</b>	 <b>5.Z1</b>	 <b>5.BF1</b>	 <b>5.CF1</b>
 <b>5.EF4</b>	 <b>5.EX1</b>	 <b>5.EX2</b>	 <b>5.EX5</b>		

# Signaltafeln Signaux



Standardtexte (Fortsetzung):  
Textes standards (suite):

Excepté riverains 5.EX8	Livreurs autorisés 5.LF1	Privé 5.PF1	Passage interdit
Riverains autorisés 5.RF1	Sortie 5.SF3	Visiteur 5.VF1	

## Bestellinformationen Informations de commande

































Signal Formate (mm) Formats signal (mm)		600 = 560 x 200 900 = 840 x 250 1200 = 1200 x 400 1500 = 1500 x 500
		400 = 400 x 200 600 = 600 x 200 900 = 900 x 300 1200 = 1200 x 400
		500 = 500 x 200 600 = 600 x 200 900 = 900 x 300
		Integrierte Signale = <input type="checkbox"/> Signaux intégrés = <input type="checkbox"/>
Material, Beschichtung Matériau, revêtement	AS (Alu, R1) AH (Alu, R2) AV (Alu, R3)	
Preisliste Liste de prix	<b>P1-17</b>	

## Rahmen und Ständer Cadres et supports

	Seite page		Seite page
 <b>R348J</b> Jordahlschienen/ glissières "Jordahl" (400x200, 500x200, 560x200, 600x200, 840x250)	50	 <b>R349J*</b> Jordahlschiene/ glissières "Jordahl" (400x200, 500x200, 560x200, 600x200)	50
 <b>R392J</b> Jordahlschienen/ glissières "Jordahl" (900x300, 1200x400, 1500x500)	50		

\* günstige Variante zu R348J/Variante à prix réduit par rapport à R348J

## Zusatzsymbole nach VSS: Symboles additionnels selon VSS:

 5.20	  5.21	 5.22	 5.23	 5.24	 5.25
 5.26	 5.27	 5.28	 5.29	 5.30	 5.31
 5.32	 5.33	 5.34	 5.35	 5.36	 5.37
 5.38	 5.39	 5.40	 5.41	 5.43	 5.50
 5.51	 5.52	 5.53	 5.54	 5.55	 5.56
 5.57	 5.58				

# Signaltafeln Signaux

## Zusatztafeln Plaques complémentaires

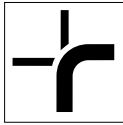

**Beispiele**  
*Exemples*

**5.09**  
Richtung der  
Hauptstrasse  
*Direction de la  
route principale*



**5.13**  
Vereiste Fahrbahn  
*Chaussée verglacée*



**5.14**  
Gehbehinderte  
*Handicapés*



**5.16**  
Schiesslärm  
*Bruit de tirs*



**5.RA**  
Radar  
*Radar*

### Bestellinformationen Informations de commande

<b>Signal Formate (mm)</b> <i>Formats signal (mm)</i>	<input type="checkbox"/> 350 <input type="checkbox"/> 500 <input type="checkbox"/> 900 <input type="checkbox"/> 1200 <input type="checkbox"/> 1500 (Standard: Radius/rayon R=30)
--	---

<b>Material, Beschichtung</b> <i>Matériau, revêtement</i>	AS (Alu, R1) AH (Alu, R2) AV (Alu, R3)
--	--

<b>Preisliste</b> <i>Liste de prix</i>	<b>P1-19</b>
---	--------------

### Rahmen und Ständer Cadres et supports

R362J Jordahlschienen/glissières "Jordahl" (350, 500, 900, 1200, 1500)	Seite <i>page</i>
--	----------------------

Seite  
*page*

**49**

## Bahnübergangs-Signalisationen Signalisation des passages à niveau



**3.20**  
Wechselblinklicht  
*Feux clignotant  
alternativement*



**3.21**  
Einfaches Blinklicht  
*Feu clignotant simple*

### Bestellinformationen Informations de commande

<b>Signal Formate (mm)</b> <i>Formats signal (mm)</i>	
--	--

1

VERKEHRSSCHILDER  
SIGNAUX ROUTIERS

SIGNAL  
SIGNAL SYSTEMS COMPANY



# Signaltafeln Signaux

## Andreaskreuze Croix de St-André

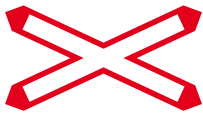

**3.22**  
Einfaches Andreaskreuz  
Croix de St-André simple



**3.24**  
Einfaches Andreaskreuz  
Croix de St-André simple

### Bestellinformationen Informations de commande

<b>Signal Formate (mm)</b> <i>Formats signal (mm)</i>	<b>3.22</b> (1200, 1550) <b>3.24</b> (1200, 1550)
<b>Material, Beschichtung</b> <i>Matériau, revêtement</i>	AH (Alu, R2)
<b>Preisliste</b> <i>Liste de prix</i>	<b>P1-117</b>

### Fundamente Fondations

<b>Modelle</b> <i>Modèles</i>	<b>EV700BE 89</b> (Ø 89, L=600) Betonsockel <i>Fondation en béton</i>
	<b>EV700FU 89X600</b> (Ø 89, L=600) Stahlfundament <i>Fondation en acier</i>
<b>Preisliste</b> <i>Liste de prix</i>	<b>P1-3</b>

### Befestigungsmaterial von Andreaskreuz, feuerverzinkt, an Rohrmast oder T-Eisenmast Matériel de fixation pour la croix de St-André, galvanisé, mât tubulaire ou sur mât en fer-T

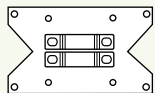

**X-02 BR**  
Befestigungsplatte mit Briden für einfaches Andreaskreuz 3.22 und 3.24, zu RM  
*Fixation avec brides pour croix de St-André simple 3.22 et 3.24, pour RM*

Format = **1550**

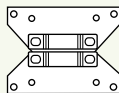

**X-03 BR**  
Befestigungsplatte mit Briden für einfaches Andreaskreuz 3.22 und 3.24, zu RM  
*Fixation avec brides pour croix de St-André simple 3.22 et 3.24, pour RM*

Format = **1200**

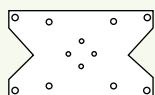

**X-02**  
Befestigungsplatte für einfaches Andreaskreuz 3.22 und 3.24, zu TM  
*Fixation pour croix de St-André simple 3.22 et 3.24, pour TM*

Format = **1550**

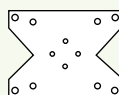

**X-03**  
Befestigungsplatte für einfaches Andreaskreuz 3.22 und 3.24, zu TM  
*Fixation pour croix de St-André simple 3.22 et 3.24, pour TM*

Format = **1200**

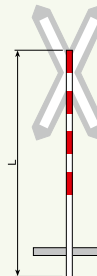

**RM 89**  
Rohrmast  
*Mât tubulaire*

Ø = 89 L = 3800  
L = 4400

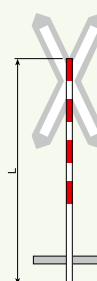

**TM**  
T-Eisenmast  
*Mât en fer-T*

T = 50 x 100 L = 3800  
L = 4400

### Bestellinformationen Informations de commande

<b>Preisliste</b> <i>Liste de prix</i>	<b>P1-120</b>	<b>P1-121</b>
---	---------------	---------------

# Schiffahrtssignale Signalisation fluviale

## Verbots- und empfehlende Zeichen Signaux d'interdiction et de recommandation



**A-12**  
Verbot, ausserhalb der angezeigten Begrenzung zu fahren  
*Interdiction de naviguer en dehors des limites indiquées*



**D-1**  
Empfohlene Durchfahrt bei Brücken  
*Passe recommandée des ponts*



**D-2**  
Empfehlung, sich auf der mit "grün" bezeichneten Fahrwasserseite zu halten  
*Recommandation de se tenir dans l'espace indiqué en "vert"*

### Bestellinformationen Informations de commande

<b>Signal Formate (mm) Formats signal (mm)</b>	◇ 800 ◇ 1000
<b>Material, Beschichtung Matériau, revêtement</b>	AS Alu, R1, Rückseite weiss RAL 9010 Verso blanc RAL 9010
<b>Preisliste Liste de prix</b>	

### Rahmen und Ständer Cadres et supports

	Seite page		Seite page
<b>R582J</b> Jordahlschienen/glissières "Jordahl"	<b>49</b>	<b>R581C</b> Typ C/type C	<b>51</b>

## Verbots-, Gebots- und Hinweiszeichen Signaux d'interdiction, d'obligation et d'indication

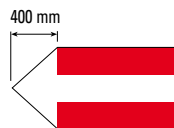

**A-1**  
Verbot der Durchfahrt (allg. Verbotsschilder)  
*Interdiction de passer (signal général d'interdiction)*

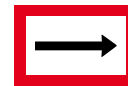

**B-1**  
Gebot, die durch den Pfeil angegebene Richtung einzuschlagen  
*Obligation de prendre la direction indiquée par la flèche*



**E-1**  
Erlaubnis zur Durchfahrt  
*Autorisation de passer*



**E-6**  
Empfohlene Fahrrichtung  
*Direction recommandée*



**E-7**  
Nicht freifahrende Fähre  
*Bac ne naviguant pas librement*



**E-8**  
Wehr  
*Barrage*

### Bestellinformationen Informations de commande

<b>Signal Formate (mm) Formats signal (mm)</b>	1000 x 800 1200 x 1000
<b>Material, Beschichtung Matériau, revêtement</b>	AS Alu, R1, Rückseite weiss RAL 9010 Verso blanc RAL 9010
<b>Preisliste Liste de prix</b>	

### Rahmen und Ständer Cadres et supports

	Seite page		Seite page
<b>R392J</b> Jordahlschienen/glissières "Jordahl"	<b>49</b>	<b>R391C</b> Typ C/type C	<b>52</b>

# Schiffahrtssignale Signalisation fluviale

## Verbots-, Gebots- und Hinweiszeichen Signaux d'interdiction, d'obligation et d'indication



**A-4bis**  
Verbot des Fahrens mit  
Segelbrettern  
*Interdiction de passer  
pour planches à voile*



**A-5**  
Überholverbot  
*Interdiction de tout  
dépassement*



**A-6**  
Verbot des Begegnens  
und Überholens  
*Interdiction de toute  
rencontre et tout  
dépassement*



**A-2**  
Verbot der Durchfahrt  
für Schiffe mit  
Maschinenantrieb  
*Interdiction de passer  
pour bateaux motorisés*



**A-3**  
Verbot des  
Wasserskifahrens  
*Interdiction de ski  
nautique*



**A-4**  
Verbot des Fahrens mit  
Segelschiffen  
*Interdiction de passer  
pour bateaux à voile*



**A-10**  
Wendeverbot  
*Interdiction de virer*



**A-11**  
Verbot schädlichen  
Wellenschlag oder Sog  
zu erzeugen  
*Interdiction de causer  
des remous ou effets de  
suction nuisibles*



**B-2**  
Gebot, unter  
bestimmten Bedin-  
gungen anzuhalten  
*Obligation de s'arrêter  
dans certaines  
conditions*



**B-3**  
Gebot, die in Stunden-  
kilometern (km/h) ange-  
gebene Geschwindigkeit  
nicht zu überschreiten  
*Obligation de ne pas  
dépasser la vitesse  
indiquée en km/h*



**B-4**  
Gebot, ein Schall-  
zeichen zu geben  
*Obligation de siffler*



**B-5**  
Gebot, besondere  
Vorsicht walten zu lassen  
*Obligation d'observer une  
vigilance particulière*



**E-2**  
Erlaubnis zum Stillliegen  
*Autorisation de stationner*



**E-3**  
Erlaubnis zum Anker  
*Autorisation d'ancrer*



**E-4**  
Erlaubnis zum  
Festmachen  
*Autorisation d'amarrer*



**E-5**  
Erlaubnis zum  
Wasserskifahren  
*Autorisation de  
ski nautique*



**E-5bis**  
Erlaubnis zum Fahren  
mit Segelbrettern  
*Autorisation pour plan-  
ches à voile*



**E-9**  
Stelle zum Einwassern  
von Schiffen  
*Lieu de mise à l'eau  
de bateaux*



**E-10**  
Stelle zum Auswassern  
von Schiffen  
*Lieu de mise à terre de  
bateaux*



**E-11**  
Ende eines Verbotes  
oder Gebotes  
*Fin d'une interdiction  
ou d'une obligation*



**E-12**  
Hochspannungs-  
Freileitung  
*Lignes aériennes à  
haute tension*



**C-1**  
Beschränkung der  
Durchfahrts Höhe (über  
dem Wasserspiegel)  
*La hauteur de la passe  
est limitée (au dessus  
du niveau de l'eau)*



**C-2**  
Beschränkte  
Durchfahrtsbreite  
*La largeur de la passe  
est limitée*



**C-3**  
Das Fahrwasser ist einge-  
engt; Abstand in Metern (m),  
in dem sich Schiffe vom Ufer  
entfernt halten sollen  
*Le chenal est limité; distance  
(m) à laquelle il convient que  
les bateaux se tiennent par  
rapport à la rive*

### Bestellinformationen Informations de commande

<b>Signal Formate (mm)</b> <i>Formats signal (mm)</i>	<input type="checkbox"/> 800
	<input type="checkbox"/> 1000
<b>Material, Beschichtung</b> <i>Matériau, revêtement</i>	AS Alu, R1, Rückseite weiss RAL 9010 Verso blanc RAL 9010
<b>Preisliste</b> <i>Liste de prix</i>	

### Rahmen und Ständer Cadres et supports

	<b>R362J</b> Jordahlschienen/glisières "Jordahl"	Seite page	49		<b>R361C</b> Typ C/type C	Seite page	52
--	---	---------------	----	--	------------------------------	---------------	----

# Schiffahrtssignale und diverse Signale Signalisation fluviale et signaux divers

## Zusätzliche Schilder und Anschriften Panneaux et inscriptions supplémentaires



Anhalten zwecks Zoll-  
abfertigung (Beispiel)  
*Arrêt pour la douane (ex-  
emple)*

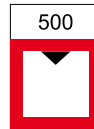

Beschränkung der Durch-  
fahrthöhe nach 500 m  
(Beispiel)  
*La hauteur de la passe est  
limitée après 500 m (exemple)*

### Bestellinformationen Informations de commande

Signal Formate (mm) Formats signal (mm)	<input type="checkbox"/>
Material, Beschichtung Matériau, revêtement	<input type="checkbox"/>
Preisliste Liste de prix	

### Rahmen und Ständer Cadres et supports

	Seite page		Seite page
R382J Jordahlschienen/ glissières "Jordahl"	49	R381C Typ C/type C	52

## Zusätzliche Schilder und Anschriften Panneaux et inscriptions supplémentaires



Erlaubnis zum Stillliegen (Beispiel)  
*Autorisation de stationner (exemple)*

### Bestellinformationen Informations de commande

Signal Formate (mm) Formats signal (mm)	<input type="checkbox"/>
Material, Beschichtung Matériau, revêtement	<input type="checkbox"/>
Preisliste Liste de prix	

### Rahmen und Ständer Cadres et supports

	Seite page		Seite page
R79J Jordahlschienen/ glissières "Jordahl"	50	R78C Typ C/type C	52
		R80C Typ C/type C	52

## Gefahrenschilder Panneaux de danger



1.30SW420x770xAS  
Schwallwasser  
Ecluses



LAW 600x700 AS  
Lawinengefahr  
Danger d'avalanches

### Bestellinformationen Informations de commande

Signal Formate (mm) Formats signal (mm)	<input type="checkbox"/>
Material, Beschichtung Matériau, revêtement	<input type="checkbox"/>
Preisliste Liste de prix	

### Rahmen und Ständer Cadres et supports

Signalträger =   
supports de signaux =

# Signaltafeln (diverse) Signaux (divers)

## Gefahrenschilder Panneaux de danger



**1.B1**  
Brandgefahr  
Danger d'incendie



**1.E1**  
Explosionsgefahr  
Danger d'explosion



**1.Z1**  
Zone, die für Badende  
gefährlich werden kann  
Zone pouvant être  
dangereuse pour les  
baigneurs

### Bestellinformationen Informations de commande

Signal Formate (mm) Formats signal (mm)	△ 600
Material, Beschichtung Matériau, revêtement	AS (Alu, R1)
Preisliste Liste de prix	<b>P1-1</b>

### Rahmen und Ständer Cadres et supports

	Seite page		
Signaflex M13F (600)	38	R325J Jordahlschienen/gliissières "Jordahl" (600)	49
Signaflex M13FA (600)	38	R323C (600)	51

## Verbotsschilder Signaux d'interdiction



**2.01B1**  
Badeverbotszone  
Zone où les bains  
sont interdits



**2.01B2**  
Bergschuh  
Souliers de montagne



**2.01B3**  
"Bleistiftabsatz"  
"Talons aiguilles"



**2.01F1**  
Fischen  
Pêche



**2.01F2**  
Fussball  
Football



**2.01F3**  
Fussballschuh  
Souliers de football



**2.01K1**  
Kennzeichen für Motor-  
wagen und Anhänger 2,3 m  
Signe distinctif de voitures  
automobiles ayant plus de  
2,3 m de largeur



**2.01N1**  
Mobiltelefon  
Téléphone mobile



**2.01R1**  
Rauchen verboten  
Défense de fumer



**2.01R2**  
Rollbrett  
Planche à roulettes



**2.01R3**  
Rollschuh  
Patins à roulettes



**2.01S1**  
Wasserspringen  
verboten  
Interdiction de  
sauter dans l'eau



**2.01S2**  
Surfen  
Surf



**2.01Z1**  
Zelten  
Camping



**2.30\*30"**  
Geschwindigkeitsbeschränkungs-Tafel für einzelne  
Fahrzeuge mit Aufschrift: 10, 15, 20, 25, 30, 40, 50, 60  
Disque indiquant la vitesse autorisée pour certains vé-  
hicules avec inscription: 10, 15, 20, 25, 30, 40, 50, 60

### Bestellinformationen Informations de commande

Signal Formate (mm) Formats signal (mm)	○ 200* ○ 300* ○ 400 ○ 600
Material, Beschichtung Matériau, revêtement	AS (Alu, R1)
Preisliste Liste de prix	<b>P1-36</b>

### Rahmen und Ständer Cadres et supports

	Seite page		Seite page
Signaflex W34F (400, 600)	40	R347J Jordahlschienen/gliissières "Jordahl" (400, 600)	49
Signaflex W34FA (400, 600)	40	R541C (400, 600)	50

\* Signalträger zu Signal 200, 300 auf Anfrage/  
Support de signaux pour signal 200, 300 sur demande

# Signaltafeln (diverse) Signaux (divers)

## Verbotsschilder Signaux d'interdiction

Betreten  
der Baustelle  
verboten

**5.B7**

Format = 400 x 200

Betreten der Baustelle  
verboten

Zufahrt  
bis Baustelle  
gestattet

**5.Z7**

Format = 400 x 200

Zufahrt bis Baustelle  
gestattet

Zubringerdienst  
bis zur Baustelle  
gestattet

**5.Z9**

Format = 400 x 200

Zubringerdienst bis  
Baustelle gestattet

Accès chantier  
autorisé

**5.AF3**

Format = 400 x 200

Accès chantier autorisé

Service à domicile  
autorisé  
jusqu'au chantier

**5.SF4**

Format = 400 x 200

Service à domicile autorisé  
jusqu'au chantier

Accès chantier  
interdit

**5.AF4**

Format = 400 x 200

Accès chantier interdit

Eintritt  
verboten

**5.E1**

Format = 400 x 200

Eintritt verboten

Entrée  
interdite

**5.EF1**

Format = 400 x 200

Entrée interdite

Durchgang  
verboten

**5.D1**

Format = 400 x 200

Durchgang verboten

Passage  
interdit

**5.PF3**

Format = 400 x 200

Passage interdit

Feuerwehr

**5.F6**

Format = 400 x 200

Feuerwehr

Service du feu

**5.SF1**

Format = 400 x 200

Service du feu

Abc DefGh

Diverse Verbotsschilder =   
Panneaux d'interdiction  
divers =

### Bestellinformationen Informations de commande

Signal Formate (mm) Formats signal (mm)	400 x 200
Material, Beschichtung Matériau, revêtement	AS (Alu, R1)
Preisliste Liste de prix	<b>P1-123</b>

Signalträger =   
Supports de signaux =

1

VERKEHRSSCHILDER  
SIGNAUX ROUTIERS

SIGNAL  
INTERBAU COMPANY

# Signaltafeln (diverse) Signaux (divers)

## "Hunde"-Tafeln Panneaux "chien"



**H12D**  
Format = 400 x 200  
Bitte Hunde an der Leine führen



**H12F**  
Format = 400 x 200  
Veuillez tenir les chiens en laisse



**H15D**  
Format = 400 x 200  
Hier nicht



**H15F**  
Format = 400 x 200  
Pas ici

### Bestellinformationen Informations de commande

Signal Formate (mm) Formats signal (mm)	400 x 200
Material, Beschichtung Matériau, revêtement	AS (Alu, R1)
Preisliste Liste de prix	<b>P1-123</b>

### Rahmen und Ständer Cadres et supports

	<b>ANRST</b> Rasenständer aus Flacheisen zum Einstecken in Boden. Support en fer plat à fixer en terre (350x100, 400x200)	Seite page	<b>52</b>
--	--	---------------	-----------



**H16**  
Hundeverbod  
Chiens interdits

### Bestellinformationen Informations de commande

Signal Formate (mm) Formats signal (mm)	<input type="radio"/> 200* <input type="radio"/> 300* <input type="radio"/> 400 <input type="radio"/> 600
Material, Beschichtung Matériau, revêtement	AS (Alu, R1)
Preisliste Liste de prix	<b>P1-36</b>

\* Signalträger zu Signal 200, 300 auf Anfrage /  
Support de signaux pour signal 200, 300 sur demande

### Rahmen und Ständer Cadres et supports

	<b>Signaflex W34F</b> (400, 600)	Seite page	<b>40</b>		<b>R347J</b> Jordahlschienen/glissières "Jordahl" (400, 600)	Seite page	<b>49</b>
	<b>Signaflex W34FA</b> (400, 600)	Seite page	<b>40</b>		<b>R541C</b> (400, 600)	Seite page	<b>50</b>



**H17**  
Hundeverbod (Beispiel)  
Chiens interdits (exemple)

### Bestellinformationen Informations de commande

Signal Formate (mm) Formats signal (mm)	350 x 500
Material, Beschichtung Matériau, revêtement	AS (Alu, R1)
Preisliste Liste de prix	<b>P1-125</b>

### Rahmen und Ständer Cadres et supports

	<b>Signaflex R54F</b> (350x500)	Seite page	<b>45</b>		<b>R382J</b> Jordahlschienen/glissières "Jordahl" (350x500)	Seite page	<b>49</b>
	<b>Signaflex R54FA</b> (350x500)	Seite page	<b>45</b>		<b>R381C</b> (350x500)	Seite page	<b>52</b>



# Signaltafeln (diverse) Signaux (divers)

## Diverse Schilder Panneaux divers

Bitte Rasen nicht betreten

Ne pas marcher sur la pelouse

BE 48769

P BE 48769

5.B5

Format = 600 x 100

Bitte Rasen nicht betreten

5.N

Format = 600 x 100

Ne pas marcher sur la pelouse

5.AN

Format = 350 x 100

Tafeln mit Autonummern (inkl. 8 Zeichen)  
Plaques avec numéros de voitures (incl. 8 signes)

5.ANP

Format = 350 x 100

Tafeln mit Autonummern (inkl. 8 Zeichen) und Parkplatzsymbol  
Plaques avec numéros de voitures (incl. 8 signes) et symbole de parage

Privat

ABC XYZ

2.50P

Format = 350 x 100

Privat  
Privé

2.50T

Format = 350 x 100

Text frei wählbar  
Texte au choix libre

### Bestellinformationen Informations de commande

Signal Formate (mm) Formats signal (mm)	350 x 100 600 x 100
Material, Beschichtung Matériau, revêtement	AS (Alu, R1)
Preisliste Liste de prix	P1-123

### Rahmen und Ständer Cadre et support

	<b>ANRST</b> (350x100) Signalträger für Autonummern zum Einstecken in Boden. Support pour plaquettes de numéros de voitures à fixer en terre.	Seite page <b>52</b>
---	---	----------------------------



5.AD

Format = 400 x 200

Abschleppdienst  
Dépannage



5.F7

Format = 400 x 200

Mat. = AH / AV

Fluchtweg linksweisend  
Issue de secours à gauche



5.F8

Format = 400 x 200

Mat. = AH / AV

Fluchtweg rechtsweisend  
Issue de secours à droite



5.FA7

Format = 200 x 400

Mat. = AH / AV

Fluchtweg linksgehend  
Issue de secours à gauche



5.FA8

Format = 200 x 400

Mat. = AH / AV

Fluchtweg rechtsgehend  
Issue de secours à droite



9.45

Format = auf Anfrage /  
sur demande  
Mat. = AH / AV

Sammelpunkt  
Point de rassemblement



5.G6

Format = 400 x 300

Gefährliche Güter (leer)  
Marchandises dangereuses (vide)

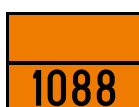

5.G7

Format = 400 x 300

Gefährliche Güter (mit Balken)  
Marchandises dangereuses (avec barre)



5.H2

Format = 500 x 400

Halt Schiessgefahr  
Danger de tirs  
Tiri a palla



5.S4

Format = 400 x 400

Kennzeichnungstafel für Schulbusse  
Signalisation pour bus d'écoliers



FOL-M

Format = 400 x 400

Kennzeichnungstafel für Schulbusse, Magnetfolie (Beispiel)  
Signalisation pour bus d'écoliers, feuille magnétique (exemple)

Abc Def  
Ghklfgh

Diverse Textschilder = □  
Panneaux avec textes divers = □

### Bestellinformationen Informations de commande

Signal Formate (mm) Formats signal (mm)	200 x 400 400 x 200 400 x 300 400 x 400 500 x 400
Material, Beschichtung Matériau, revêtement	AS (Alu, R1) AH (Alu, R2) AV (Alu, R3)

### Rahmen und Ständer Cadres et supports

Signalträger = □  
supports de signaux = □

# Signaltafeln (diverse) Signaux (divers)

## Diverse Schilder Panneaux divers

### Bestellinformationen Informations de commande

<b>Signal Formate (mm)</b> <b>Formats signal (mm)</b>	<b>905 x 1280</b> <b>980 x 1355</b> (Standard: Radius/rayon R=30)
<b>Material, Beschichtung</b> <b>Matériau, revêtement</b>	<b>AS</b> (Alu, R1) <b>PA</b> Kunststoff-Folie/ Feuille synthétique
<b>Preisliste</b> <b>Liste de prix</b>	<b>P1-125</b>



**7.D1PA**  
Format = 905x1280  
Mat. = PA  
Dieses Wochenende  
Abstimmung



**7.H2PA**  
Format = 905x1280  
Mat. = PA  
Heute Abstimmung



**7.01PA**  
Format = 905x1280  
Mat. = PA  
On vote aujourd'hui



**7.V1PA**  
Format = 905x1280  
Mat. = PA  
Oggi si vota



**7.A1PA**  
Format = 980 x 1355  
Mat. = Alum.  
Roh  
brut



**7.H1PA**  
Format = 905x1280  
Mat. = PA  
Heute Gemeinde-  
versammlung



**7.A2PA**  
Format = 905x1280  
Mat. = PA  
Aujourd'hui assemblée  
communale



**7.02PA**  
Format = 905x1280  
Mat. = PA  
Oggi assemblea com-  
munale

PA = wasserfeste Kunststoff-Folie  
PA = Feuille en matière synthétique imperméable

Auf Wunsch setzen wir Ihnen auch einen anderen Text auf das Plakat  
Selon vos désirs, nous pouvons également imprimer un autre texte sur l'affiche



**5.A21**  
Format = 500 x 700  
Mat. = AS  
Achtung kein Feuer  
machen



**5.AF2**  
Format = 500 x 700  
Mat. = AS  
Attention évitez de faire  
du feu



**5.A20**  
Format = 500 x 700  
Mat. = AS  
Attenzione non provo-  
care incendi



**5.F2**  
Format = 500 x 700  
Mat. = AS  
Freiwillig 30 km/h



**5.FF2**  
Format = 500 x 700  
Mat. = AS  
Soyez sympa 30 km/h



**5.FR2**  
Format = 500 x 700  
Mat. = AS  
Volontari 30 km/h

### Bestellinformationen Informations de commande

<b>Signal Formate (mm)</b> <b>Formats signal (mm)</b>	<b>500 x 700</b> (Standard: Radius/rayon R=30)
<b>Material, Beschichtung</b> <b>Matériau, revêtement</b>	<b>AS</b> (Alu, R1)
<b>Preisliste</b> <b>Liste de prix</b>	<b>P1-125</b>

### Rahmen und Ständer Cadres et supports

	Seite page		Seite page
<b>Signaflex R54F</b> (500x700)	<b>45</b>	<b>Signaflex R54F</b> Plakatständer/ Support pour panneaux d'affichage (980x1355)	<b>44</b>
<b>Signaflex R54FA</b> (500x700)	<b>45</b>	<b>B54 (Betonsockel/ socle de fondation)</b> Plakatständer/ Support pour panneaux d'affichage (980x1355)	<b>44</b>
<b>R382J</b> Jordahlschienen/gliissières "Jordahl" (500x700)	<b>49</b>	<b>WR 03.433 ASEN</b> (Wechselrahmen CLIP / Panneau à CLIP) (905x1280)	<b>45</b>
<b>R381C</b> (500x700)	<b>52</b>		

# Signalträger Supports de signaux

**Signaflex M13F** mit Fundamentsockel, Mauerbride oder zum Einbetonieren  
*avec socle de fondation, bride murale ou à bétonner*

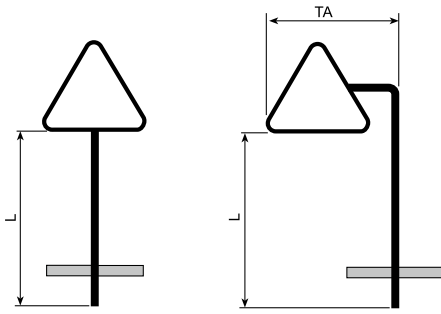

M13F		M13FA	
Format =	600	Format =	600
Format =	900	Format =	900
L =	1600	L =	3000
L =	2100	L =	... (ind.)
L =	2500	TA (Δ 600) =	860
L =	2800	TA (Δ 900) =	1080
L =	3100	TA =	... (ind.)
L =	... (ind.)		

Preisliste Liste de prix		P1-2	
Verankerung Ancrage	Seite page	55	
Einzelteile Pièces détachées	Seite page	47	

mit Flanschbefestigung oder Bodenhülse  
*avec flasque ou avec douille*

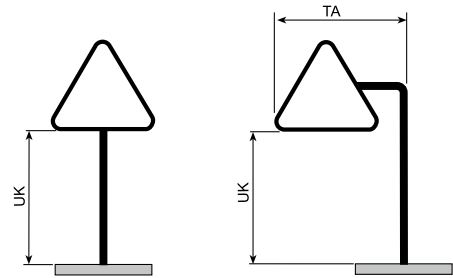

M13F		M13FA	
Format =	600	Format =	600
Format =	900	Format =	900
UK =	2100	UK =	2500
UK =	2500	UK =	... (ind.)
UK =	2800	TA (Δ 600) =	860
UK =	... (ind.)	TA (Δ 900) =	1080
		TA =	... (ind.)

Preisliste Liste de prix		P1-7	
Verankerung Ancrage	Seite page	55	
Einzelteile Pièces détachées	Seite page	47	

**Signaflex M14F** mit Fundamentsockel, Mauerbride oder zum Einbetonieren  
*avec socle de fondation, bride murale ou à bétonner*

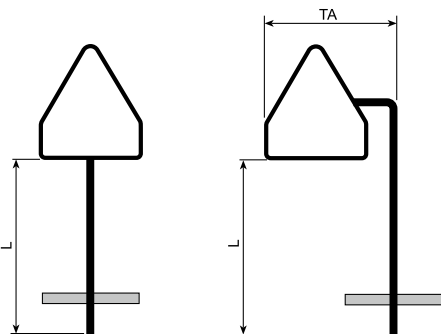

M14F		M14FA	
Format =	600	Format =	600
Format =	900	Format =	900
L =	1600	L =	3000
L =	2100	L =	... (ind.)
L =	2500	TA (Δ 600) =	920
L =	2800	TA (Δ 900) =	1150
L =	3100	TA =	... (ind.)
L =	... (ind.)		

Preisliste Liste de prix		P1-25	
Verankerung Ancrage	Seite page	55	
Einzelteile Pièces détachées	Seite page	47	

mit Flanschbefestigung oder Bodenhülse  
*avec flasque ou avec douille*

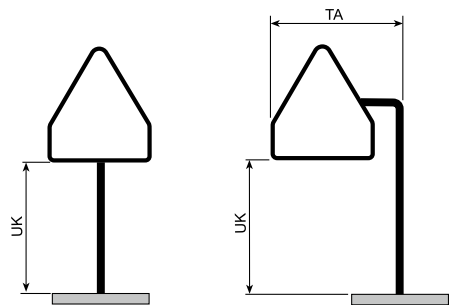

M14F		M14FA	
Format =	600	Format =	600
Format =	900	Format =	900
UK =	2100	UK =	2500
UK =	2500	UK =	... (ind.)
UK =	2800	TA (Δ 600) =	920
UK =	... (ind.)	TA (Δ 900) =	1150
		TA =	... (ind.)

Preisliste Liste de prix		P1-27	
Verankerung Ancrage	Seite page	55	
Einzelteile Pièces détachées	Seite page	47	

# Signalträger Supports de signaux

## Signaflex M17F

mit Fundamentsockel, Mauerbride oder zum Einbetonieren  
avec socle de fondation, bride murale ou à bétonner

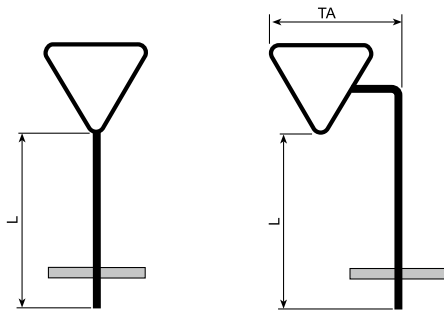

<b>M17F</b>	
Format = 600	
Format = 900	
L = 1600	
L = 2100	
L = 2500	
L = 2800	
L = 3100	
L = ... (ind.)	

<b>M17FA</b>	
Format = 600	
Format = 900	
L = 3000	
L = ... (ind.)	
TA (▽600) = 860	
TA (▽900) = 1080	
TA = ... (ind.)	

<b>Preisliste</b> <i>Liste de prix</i>		<b>P1-2</b>
<b>Verankerung</b> <i>Ancrage</i>	Seite <i>page</i>	<b>55</b>
<b>Einzelteile</b> <i>Pièces détachées</i>	Seite <i>page</i>	<b>47</b>

mit Flanschbefestigung oder Bodenhülse  
avec flasque ou avec douille

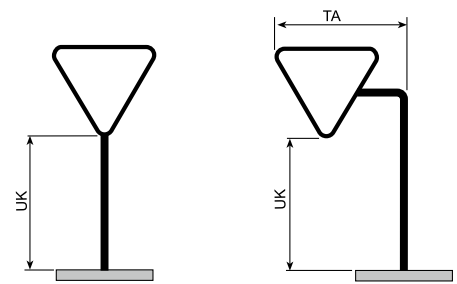

<b>M17F</b>	
Format = 600	
Format = 900	
UK = 2100	
UK = 2500	
UK = 2800	
UK = ... (ind.)	

<b>M17FA</b>	
Format = 600	
Format = 900	
UK = 2500	
UK = ... (ind.)	
TA (▽600) = 860	
TA (▽900) = 1080	
TA = ... (ind.)	

<b>Preisliste</b> <i>Liste de prix</i>		<b>P1-7</b>
<b>Verankerung</b> <i>Ancrage</i>	Seite <i>page</i>	<b>55</b>
<b>Einzelteile</b> <i>Pièces détachées</i>	Seite <i>page</i>	<b>47</b>

## Signaflex M18F

mit Fundamentsockel, Mauerbride oder zum Einbetonieren  
avec socle de fondation, bride murale ou à bétonner

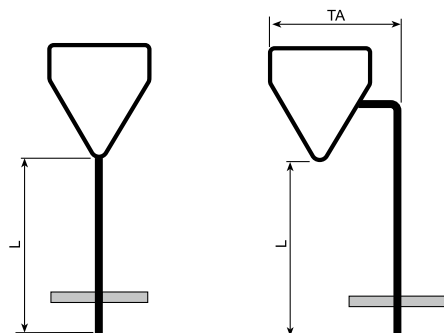

<b>M18F</b>	
Format = 600	
Format = 900	
L = 1600	
L = 2100	
L = 2500	
L = 2800	
L = 3100	
L = ... (ind.)	

<b>M18FA</b>	
Format = 600	
Format = 900	
L = 3000	
L = ... (ind.)	
TA (▽600) = 920	
TA (▽900) = 1150	
TA = ... (ind.)	

<b>Preisliste</b> <i>Liste de prix</i>		<b>P1-25</b>
<b>Verankerung</b> <i>Ancrage</i>	Seite <i>page</i>	<b>55</b>
<b>Einzelteile</b> <i>Pièces détachées</i>	Seite <i>page</i>	<b>47</b>

mit Flanschbefestigung oder Bodenhülse  
avec flasque ou avec douille

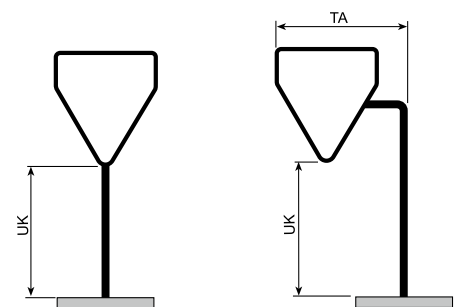

<b>M18F</b>	
Format = 600	
Format = 900	
UK = 2100	
UK = 2500	
UK = 2800	
UK = ... (ind.)	

<b>M18FA</b>	
Format = 600	
Format = 900	
UK = 2500	
UK = ... (ind.)	
TA (▽600) = 920	
TA (▽900) = 1150	
TA = ... (ind.)	

<b>Preisliste</b> <i>Liste de prix</i>		<b>P1-27</b>
<b>Verankerung</b> <i>Ancrage</i>	Seite <i>page</i>	<b>55</b>
<b>Einzelteile</b> <i>Pièces détachées</i>	Seite <i>page</i>	<b>47</b>

# Signalträger Supports de signaux

**Signaflex W34F** mit Fundamentsockel, Mauerbride oder zum Einbetonieren  
*avec socle de fondation, bride murale ou à bétonner*

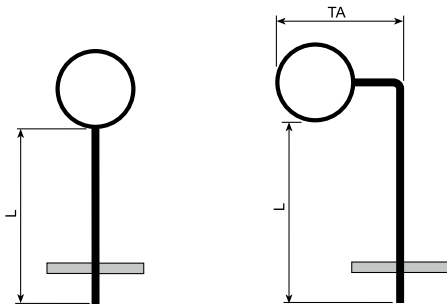

W34F		W34FA	
Format	= 400	Format	= 400
Format	= 600	Format	= 600
L	= 1600	L	= 3000
L	= 2100	L	= ...(ind.)
L	= 2500	TA (⊙400)	= 820
L	= 2800	TA (⊙600)	= 1020
L	= 3100	TA	= ...(ind.)
L	= ...(ind.)		

Preisliste Liste de prix		P1-37	
Verankerung Ancrage	Seite page	55	
Einzelteile Pièces détachées	Seite page	47	

mit Flanscbefestigung oder Bodenhülse  
*avec flasque ou avec douille*

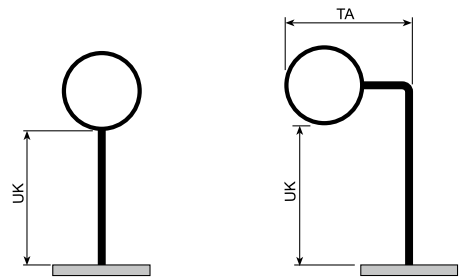

W34F		W34FA	
Format	= 400	Format	= 400
Format	= 600	Format	= 600
UK	= 2100	UK	= 2500
UK	= 2500	UK	= ...(ind.)
UK	= 2800	TA (⊙400)	= 820
UK	= ...(ind.)	TA (⊙600)	= 1020
		TA	= ...(ind.)

Preisliste Liste de prix		P1-39	
Verankerung Ancrage	Seite page	55	
Einzelteile Pièces détachées	Seite page	47	

**Signaflex W35F** mit Fundamentsockel, Mauerbride oder zum Einbetonieren  
*avec socle de fondation, bride murale ou à bétonner*

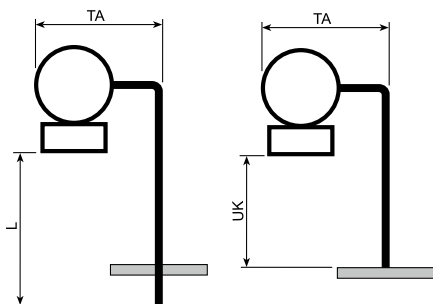

W35FA		W35FA	
Format	= 400	Format	= 400
Format	= 600	Format	= 600
L	= 3000	UK	= 2500
L	= ...(ind.)	UK	= ...(ind.)
TA (⊙ 400)	= 820	TA (⊙ 400)	= 820
TA (⊙ 600)	= 1020	TA (⊙ 600)	= 1020
TA ⊙	= ...(ind.)	TA ⊙	= ...(ind.)

Preisliste Liste de prix		P1-43		P1-45	
Verankerung Ancrage	Seite page	55		55	
Einzelteile Pièces détachées	Seite page	47		47	

**Signaflex W3434F** mit Fundamentsockel, Mauerbride oder zum Einbetonieren  
*avec socle de fondation, bride murale ou à bétonner*

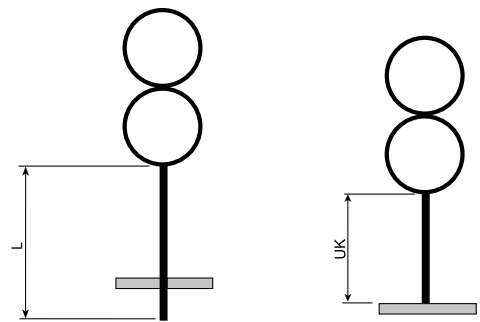

W3434F	
Format	= 400
Format	= 600
UK	= 2100
UK	= 2500
UK	= 2800
UK	= ...(ind.)

Preisliste Liste de prix		P1-49		P1-50	
Verankerung Ancrage	Seite page	55		55	
Einzelteile Pièces détachées	Seite page	47		47	

# Signalträger Supports de signaux

## Signaflex E34F

mit Fundamentsockel, Mauerbride oder zum Einbetonieren  
avec socle de fondation, bride murale ou à bétonner

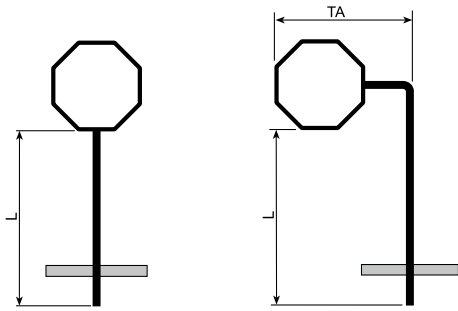

E34F	
Format	= 500
Format	= 600
L	= 1600
L	= 2100
L	= 2500
L	= 2800
L	= 3100
L	= ... (ind.)

E34FA	
Format	= 500
Format	= 600
L	= 3000
L	= ... (ind.)
TA (○500)	= 920
TA (○600)	= 1020
TA	= ... (ind.)

Preisliste Liste de prix		P1-55
Verankerung Ancrage	Seite page	55
Einzelteile Pièces détachées	Seite page	47

mit Flanscbefestigung oder Bodenhülse  
avec flasque ou avec douille

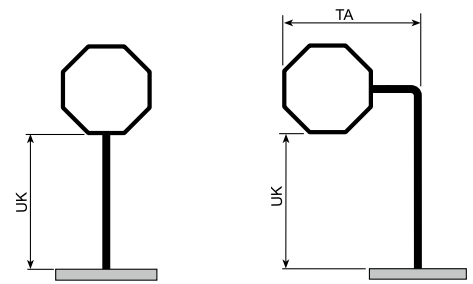

E34F	
Format	= 500
Format	= 600
UK	= 2100
UK	= 2500
UK	= 2800
UK	= ... (ind.)

E34FA	
Format	= 500
Format	= 600
UK	= 2500
UK	= ... (ind.)
TA (○500)	= 920
TA (○600)	= 1020
TA	= ... (ind.)

Preisliste Liste de prix		P1-57
Verankerung Ancrage	Seite page	55
Einzelteile Pièces détachées	Seite page	47

1

# Signalträger Supports de signaux

## Signaflex R50F

mit Fundamentsockel, Mauerbride oder zum Einbetonieren  
avec socle de fondation, bride murale ou à bétonner

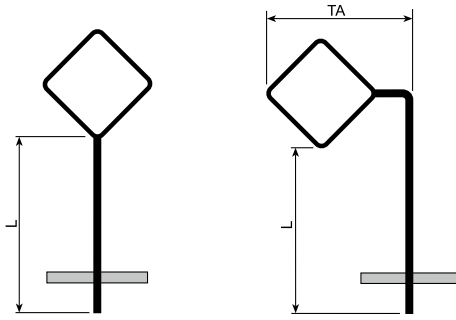

### R50F

Format =	350
Format =	500
Format =	700
L =	1600
L =	2100
L =	2500
L =	2800
L =	3100
L =	...(ind.)

### R50FA

Format =	350
Format =	500
Format =	700
L =	3000
L =	...(ind.)
TA (<math>\triangleleft 350</math>) =	890
TA (<math>\triangleleft 500</math>) =	1100
TA (<math>\triangleleft 700</math>) =	1380
TA =	...(ind.)

### Preisliste Liste de prix

**P1-65**

<b>Verankerung Ancrage</b>	Seite page	<b>55</b>
<b>Einzelteile Pièces détachées</b>	Seite page	<b>47</b>

mit Flanschbefestigung oder Bodenhülse  
avec flasque ou avec douille

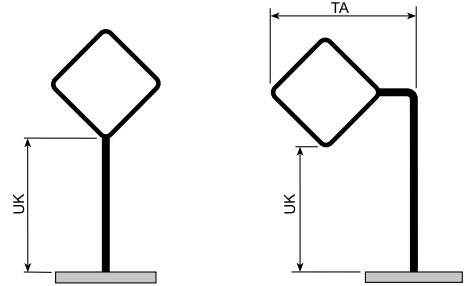

### R50F

Format =	350
Format =	500
Format =	700
UK =	2100
UK =	2500
UK =	2800
UK =	...(ind.)

### R50FA

Format =	350
Format =	500
Format =	700
UK =	2500
UK =	...(ind.)
TA (<math>\triangleleft 350</math>) =	890
TA (<math>\triangleleft 500</math>) =	1100
TA (<math>\triangleleft 700</math>) =	1380
TA =	...(ind.)

### Preisliste Liste de prix

**P1-67**

<b>Verankerung Ancrage</b>	Seite page	<b>55</b>
<b>Einzelteile Pièces détachées</b>	Seite page	<b>47</b>

## Signaflex E35F

mit Fundamentsockel, Mauerbride oder zum Einbetonieren  
avec socle de fondation, bride murale ou à bétonner

mit Flanschbefestigung oder Bodenhülse  
avec flasque ou avec douille

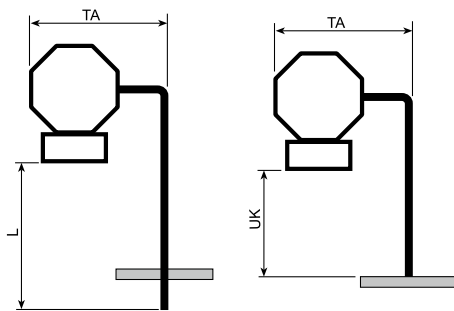

### E35FA

Format =	500
Format =	600
L =	3000
L =	...(ind.)
TA (<math>\triangleleft 500</math>) =	920
TA (<math>\triangleleft 600</math>) =	1020
TA =	...(ind.)

### E35FA

Format =	500
Format =	600
UK =	2500
UK =	...(ind.)
TA (<math>\triangleleft 500</math>) =	920
TA (<math>\triangleleft 600</math>) =	1020
TA =	...(ind.)

### Preisliste Liste de prix

**P1-60**

**P1-62**

<b>Verankerung Ancrage</b>	Seite page	<b>55</b>		<b>55</b>
<b>Einzelteile Pièces détachées</b>	Seite page	<b>47</b>		<b>47</b>

## Signaflex R5350FA

mit Fundamentsockel, Mauerbride oder zum Einbetonieren  
avec socle de fondation, bride murale ou à bétonner

mit Flanschbefestigung oder Bodenhülse  
avec flasque ou avec douille

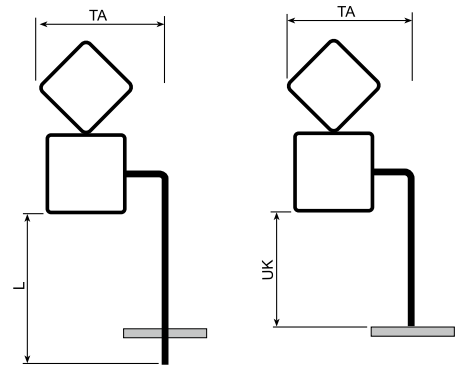

### R5350FA

Format =	$\diamond 350$ , $\square 500$
Format =	$\diamond 500$ , $\square 600$
L =	3000
TA (<math>\triangleleft 350</math>) =	930
TA (<math>\triangleleft 500</math>) =	1030
TA =	...(ind.)

### R5350FA

Format =	$\diamond 350$ , $\square 500$
Format =	$\diamond 500$ , $\square 600$
UK =	2500
TA (<math>\triangleleft 350</math>) =	930
TA (<math>\triangleleft 500</math>) =	1030
TA =	...(ind.)

### Preisliste Liste de prix

**P1-71**

**P1-72**

<b>Verankerung Ancrage</b>	Seite page	<b>55</b>		<b>55</b>
<b>Einzelteile Pièces détachées</b>	Seite page	<b>47</b>		<b>47</b>



# Signalträger Supports de signaux

## Signaflex R64F

mit Fundamentsockel, Mauerbride oder zum Einbetonieren  
avec socle de fondation, bride murale ou à bétonner

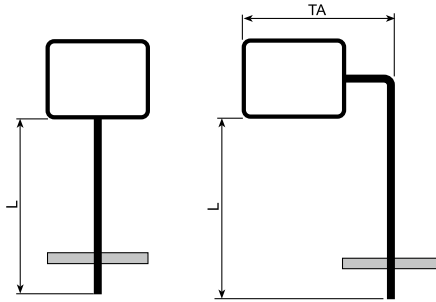

R64F		R64FA	
Format =	500 x 350	Format =	500 x 350
Format =	700 x 500	Format =	700 x 500
Format =	1000 x 700	Format =	1000 x 700
L =	1600	L =	3000
L =	2100	L =	...(ind.)
L =	2500	TA (500x350) =	920
L =	2800	TA (700x500) =	1120
L =	3100	TA (1000x700) =	1440
L =	...(ind.)	TA =	...(ind.)

Preisliste Liste de prix		P1-74	
Verankerung Ancrage	Seite page	55	
Einzelteile Pièces détachées	Seite page	47	

mit Flanschbefestigung oder Bodenhülse  
avec flasque ou avec douille

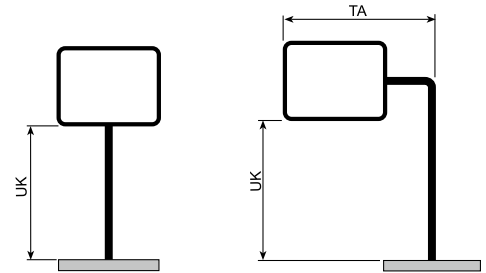

R64F		R64FA	
Format =	500 x 350	Format =	500 x 350
Format =	700 x 500	Format =	700 x 500
Format =	1000 x 700	Format =	1000 x 700
UK =	2100	UK =	2500
UK =	2500	UK =	...(ind.)
UK =	2800	TA (500x350) =	920
UK =	...(ind.)	TA (700x500) =	1120
		TA (1000x700) =	1440
		TA =	...(ind.)

Preisliste Liste de prix		P1-76	
Verankerung Ancrage	Seite page	55	
Einzelteile Pièces détachées	Seite page	47	

## Signaflex R6434F

mit Fundamentsockel, Mauerbride oder zum Einbetonieren  
avec socle de fondation, bride murale ou à bétonner

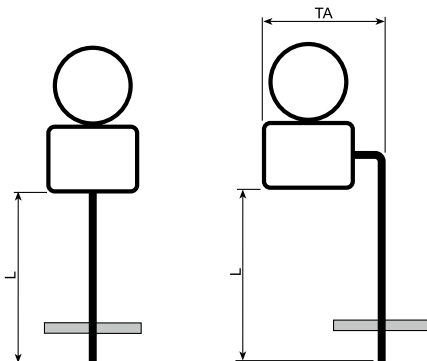

R6434F		R6434FA	
Format =	700 x 500 + 600	Format =	700 x 500 + 600
Format =	1000 x 700 + 600	Format =	1000 x 700 + 600
L =	1600	L =	3000
L =	2100	L =	...(ind.)
L =	2500	TA (700x500) =	1120
L =	2800	TA (1000x700) =	1440
L =	3100	TA =	...(ind.)
L =	...(ind.)		

Preisliste Liste de prix		P1-81	
Verankerung Ancrage	Seite page	55	
Einzelteile Pièces détachées	Seite page	47	

mit Flanschbefestigung oder Bodenhülse  
avec flasque ou avec douille

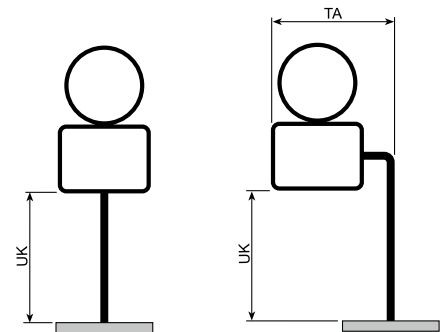

R6434F		R6434FA	
Format =	700 x 500 + 600	Format =	700 x 500 + 600
Format =	1000 x 700 + 600	Format =	1000 x 700 + 600
UK =	2100	UK =	2500
UK =	2500	UK =	...(ind.)
UK =	2800	TA (700x500) =	1120
UK =	...(ind.)	TA (1000x700) =	1440
		TA =	...(ind.)

Preisliste Liste de prix		P1-83	
Verankerung Ancrage	Seite page	55	
Einzelteile Pièces détachées	Seite page	47	

# Signalträger Supports de signaux

## Signaflex R53F

mit Fundamentsockel, Mauerbride oder zum Einbetonieren  
avec socle de fondation, bride murale ou à bétonner

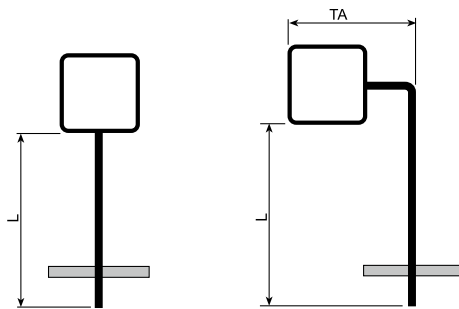

R53F		R53FA	
Format =	350	Format =	350
Format =	500	Format =	500
Format =	700	Format =	700
Format =	900	Format =	900
L =	1600	L =	3000
L =	2100	L =	...(ind.)
L =	2500	TA (350) =	780
L =	2800	TA (500) =	930
L =	3100	TA (700) =	1130
L =	...(ind.)	TA =	...(ind.)

Preisliste Liste de prix		P1-87	
Verankerung Ancrage	Seite page	55	
Einzelteile Pièces détachées	Seite page	47	

mit Flanschbefestigung oder Bodenhülse  
avec flasque ou avec douille

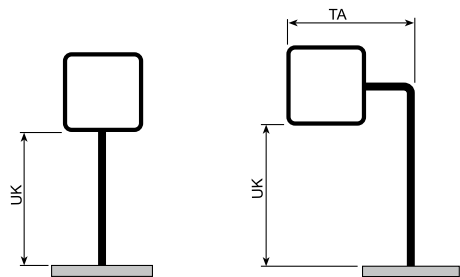

R53F		R53FA	
Format =	350	Format =	350
Format =	500	Format =	500
Format =	700	Format =	700
UK =	2100	UK =	2500
UK =	2500	UK =	...(ind.)
UK =	2800	TA (350) =	780
UK =	...(ind.)	TA (500) =	930
		TA (700) =	1130
		TA =	...(ind.)

Preisliste Liste de prix		P1-89	
Verankerung Ancrage	Seite page	55	
Einzelteile Pièces détachées	Seite page	47	

## Signaflex R54F

mit Fundamentsockel,  
Mauerbride oder  
zum Einbetonieren  
avec socle de fondation,  
bride murale ou à bétonner

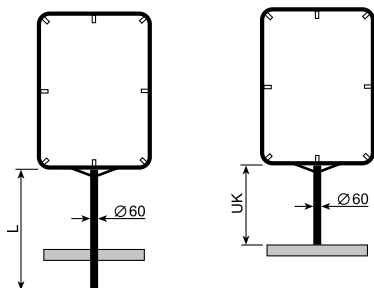

R54F		R54F	
Format =	980 x 1355	Format =	980 x 1355
L =	1100	UK =	600
L =	...(ind.)	UK =	...(ind.)

mit Flanschbefestigung  
oder Bodenhülse  
avec flasque ou avec  
douille

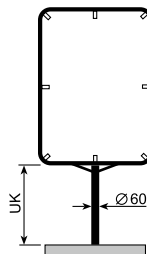

## B54

mit Betonsocle  
avec socle de fondation

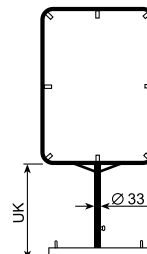

B54		B54	
Format =	350 x 500	Format =	980 x 1355
Format =	426 x 750	UK =	600
Format =	500 x 700	UK =	...(ind.)
UK =	1350		
UK =	...(ind.)		

Preisliste Liste de prix		P1-95		P1-97	
Verankerung Ancrage	Seite page	55		55	

Preisliste Liste de prix		P1-126	
Verankerung Ancrage	Seite page	55	

# Signalträger Supports de signaux

## Signaflex R54F

mit Fundamentsockel, Mauerbride oder zum Einbetonieren  
avec socle de fondation, bride murale ou à bétonner

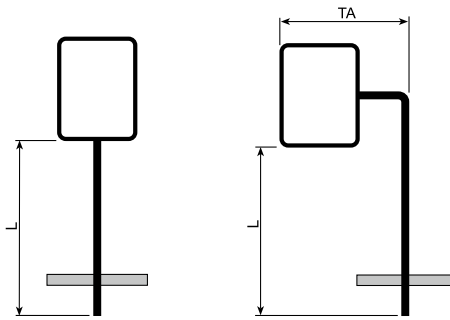

### R54F

Format =	350 x 500
Format =	426 x 750
Format =	500 x 700
Format =	700 x 1000
L =	1600
L =	2100
L =	2500
L =	2800
L =	3100
L =	... (ind.)

### R54FA

Format =	350 x 500
Format =	426 x 750
Format =	500 x 700
Format =	700 x 1000
L =	3000
L =	... (ind.)
TA (350x500) =	770
TA (426x750) =	850
TA (500x700) =	920
TA (700x1000) =	1140
TA =	... (ind.)

### R54GF

Format =	660 x 1000
L =	1600
L =	2100
L =	2500
L =	... (ind.)

<b>Preisliste</b> <i>Liste de prix</i>		<b>P1-95</b>
<b>Verankerung</b> <i>Ancrage</i>	Seite <i>page</i>	<b>55</b>
<b>Einzelteile</b> <i>Pièces détachées</i>	Seite <i>page</i>	<b>47</b>

mit Flanscbefestigung oder Bodenhülse  
avec flasque ou avec douille

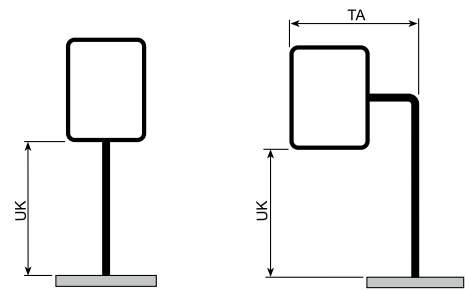

### R54F

Format =	350 x 500
Format =	426 x 750
Format =	500 x 700
Format =	700 x 1000
UK =	2100
UK =	2500
UK =	2800
UK =	... (ind.)

### R54FA

Format =	350 x 500
Format =	426 x 750
Format =	500 x 700
Format =	700 x 1000
UK =	2500
UK =	... (ind.)
TA (350x500) =	770
TA (426x750) =	850
TA (500x700) =	920
TA (700x1000) =	1140
TA =	... (ind.)

<b>Preisliste</b> <i>Liste de prix</i>		<b>P1-97</b>
<b>Verankerung</b> <i>Ancrage</i>	Seite <i>page</i>	<b>55</b>
<b>Einzelteile</b> <i>Pièces détachées</i>	Seite <i>page</i>	<b>47</b>

## Wechselrahmen CLIP Panneau à CLIP

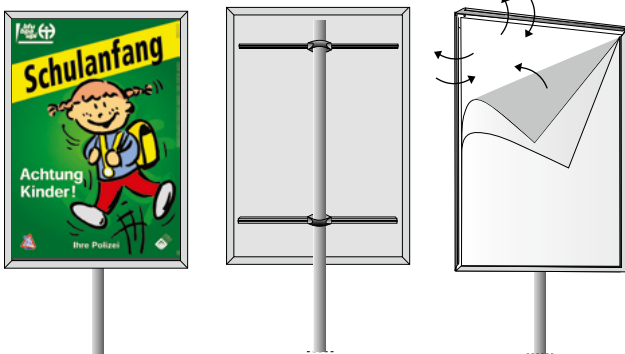

**Preisliste**  
*Liste de prix*

**P1-129**

### WR 03.433 ASEN

Format = 905x1280

Aluminium-Rahmen naturel oxidiert, mit Alu-Rückwand, Wasserdicht, inkl. 2 Profilschienen für Montage mittels Briden oder Stahlband, Front mit Anti-Reflex-Schutzfolie  
*Cadre en aluminium, éloxé naturel, avec dos et 2 rails en aluminium, étanche, pour le montage avec brides ou bande en acier, front avec feuille de protection anti-réfl.*

### WR CLIP

Format = 905x1280

wie WR 03.433 ASEN, jedoch ohne Profilschienen  
*idem WR 03.433 ASEN, mais sans rails en aluminium*

### ZT 19.028

Rahmenöffner aus Kunststoff  
*Ouvreur de cadre en mat. synth.*

### ARF 905

Format = 927x1302

Anti-Reflex-Schutzfolie zu WR Clip  
*Feuille de protection anti-réflexion pour WR Clip*

### Signalträger

*Supports de signaux*

Rohrmasten **RM60** mit 2 Alu-Briden **BR 60 ALU/BR 76 ALU** oder **BR 90 ALU** und Verankerung **EV700BE 60**  
*Mâts tubulaires RM60 avec 2 brides en alu BR 60 ALU/BR 76 ALU ou BR 90 ALU et ancrage EV700BE 60*

oder/ou

Rohrmasten **RM33** mit 2 Briden feuerverzinkt **BR 33 FV** und Betonsockel **BE35/67/80**  
*Mâts tubulaires B33 avec 2 brides galvanisées BR 33 FV et socle en béton BE35/67/80*

# Signalträger Supports de signaux

## Signaflex R71F

mit Fundamentsockel,  
Mauerbride oder  
zum Einbetonieren  
*avec socle de fondation,  
bride murale ou à bétonner*

mit Flanschbefestigung  
oder Bodenhülse  
*avec flasque ou  
avec douille*

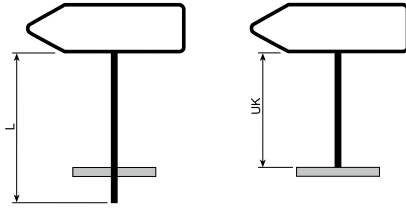

### R71F

Format = 1020 x 200  
Format = 1020 x 250  
Format = 1020 x 450  
Format = 1300 x 200  
Format = 1300 x 250  
Format = 1300 x 300  
Format = 1300 x 350  
Format = 1300 x 450  
Format = 1300 x 550  
Format = 1300 x 650  
Format = 1600 x 200  
Format = 1600 x 250  
Format = 1600 x 300  
Format = 1600 x 350  
Format = 1600 x 450  
Format = 1600 x 550  
Format = 1600 x 650

L = 1600  
L = 2100  
L = 2500  
L = 2800  
L = 3100  
L = ... (ind.)

### R71F

Format = 1020 x 200  
Format = 1020 x 250  
Format = 1020 x 450  
Format = 1300 x 200  
Format = 1300 x 250  
Format = 1300 x 300  
Format = 1300 x 350  
Format = 1300 x 450  
Format = 1300 x 550  
Format = 1300 x 650  
Format = 1600 x 200  
Format = 1600 x 250  
Format = 1600 x 300  
Format = 1600 x 350  
Format = 1600 x 450  
Format = 1600 x 550  
Format = 1600 x 650

UK = 2100  
UK = 2500  
UK = 2800  
UK = ... (ind.)

## Signaflex 271F

mit Fundamentsockel,  
Mauerbride oder  
zum Einbetonieren  
*avec socle de fondation,  
bride murale ou à bétonner*

mit Flanschbefestigung  
oder Bodenhülse  
*avec flasque ou  
avec douille*

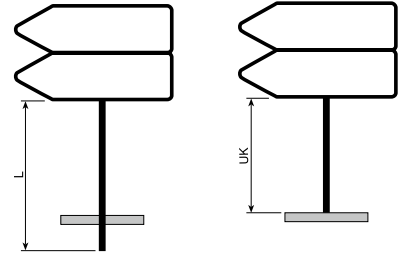

### R271F

Format = 1020 x 200  
Format = 1020 x 250  
Format = 1300 x 200  
Format = 1300 x 250  
Format = 1300 x 300  
Format = 1300 x 350

L = 1600  
L = 2100  
L = 2500  
L = 2800  
L = 3100  
L = ... (ind.)

### R271F

Format = 1020 x 200  
Format = 1020 x 250  
Format = 1300 x 200  
Format = 1300 x 250  
Format = 1300 x 300  
Format = 1300 x 350

UK = 2100  
UK = 2500  
UK = 2800  
UK = ... (ind.)

## Signaflex R276F

mit Fundamentsockel,  
Mauerbride oder  
zum Einbetonieren  
*avec socle de fondation,  
bride murale ou à bétonner*

mit Flanschbefestigung  
oder Bodenhülse  
*avec flasque ou  
avec douille*

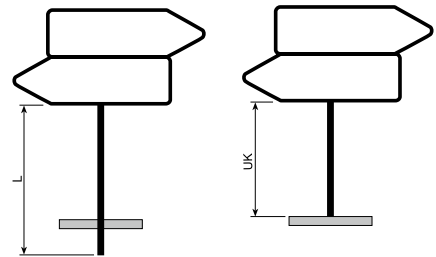

### R276F

Format = 1020 x 200  
Format = 1020 x 250  
Format = 1300 x 200  
Format = 1300 x 250  
Format = 1300 x 300  
Format = 1300 x 350

L = 1600  
L = 2100  
L = 2500  
L = 2800  
L = 3100  
L = ... (ind.)

### R276F

Format = 1020 x 200  
Format = 1020 x 250  
Format = 1300 x 200  
Format = 1300 x 250  
Format = 1300 x 300  
Format = 1300 x 350

UK = 2100  
UK = 2500  
UK = 2800  
UK = ... (ind.)

Preisliste Liste de prix		P1-103	P1-105
Verankerung Ancrage	Seite page	55	55
Einzelteile Pièces détachées	Seite page	47	47

Preisliste Liste de prix		P1-109	P1-111
Verankerung Ancrage	Seite page	55	55
Einzelteile Pièces détachées	Seite page	47	47

# Einzelteile zu Signaflex Pièces détachées pour Signaflex

## Rohrrahmen Cadres tubulaires



**A13F**  
Format = 600  
Format = 900



**A17FA**  
Format = 600  
Format = 900

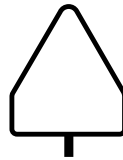

**A14F**  
Format = 600  
Format = 900

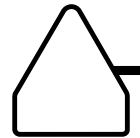

**A14FA**  
Format = 600  
Format = 900

<b>Preisliste</b> <i>Liste de prix</i>	<b>P1-4</b>	<b>P1-4</b>	<b>P1-26</b>	<b>P1-26</b>
<b>Rohrmasten Ø60</b> <i>Mâts tubulaires Ø60</i>	Seite page	54	54	54

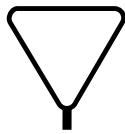

**A17F**  
Format = 600  
Format = 900

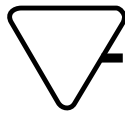

**A17FA**  
Format = 600  
Format = 900



**A18F**  
Format = 600  
Format = 900

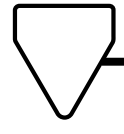

**A14FA**  
Format = 600  
Format = 900



**A171FA**  
Format = 600  
Format = 900

<b>Preisliste</b> <i>Liste de prix</i>	<b>P1-4</b>	<b>P1-4</b>	<b>P1-26</b>	<b>P1-26</b>	<b>P1-26</b>
<b>Rohrmasten Ø60</b> <i>Mâts tubulaires Ø60</i>	Seite page	54	54	54	54

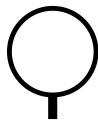

**A34F**  
Format = 400  
Format = 600



**A34FA**  
Format = 400  
Format = 600



**A35FA**  
Format = 400  
Format = 600

<b>Preisliste</b> <i>Liste de prix</i>	<b>P1-38</b>	<b>P1-38</b>	<b>P1-34</b>
<b>Rohrmasten Ø60</b> <i>Mâts tubulaires Ø60</i>	Seite page	54	54

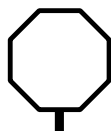

**A34EF**  
Format = 500  
Format = 600

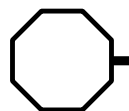

**A34EFA**  
Format = 500  
Format = 600

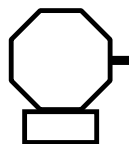

**A35EFA**  
Format = 500  
Format = 600

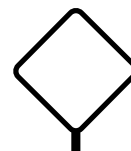

**A50F**  
Format = 350  
Format = 500  
Format = 700

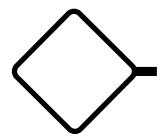

**A50F**  
Format = 350  
Format = 500  
Format = 700

<b>Preisliste</b> <i>Liste de prix</i>	<b>P1-56</b>	<b>P1-56</b>	<b>P1-61</b>	<b>P1-66</b>	<b>P1-66</b>
<b>Rohrmasten Ø60</b> <i>Mâts tubulaires Ø60</i>	Seite page	54	54	54	54

# Einzelteile zu Signaflex Pièces détachées pour Signaflex

## Rohrrahmen Cadres tubul.



**A5350FA**

Format = 350  
Format = 500

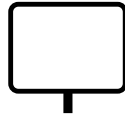

**A64F**

Format = 500 x 350  
Format = 700 x 500  
Format = 1000 x 700



**A54F**

Format = 350 x 500  
Format = 500 x 700  
Format = 700 x 1000

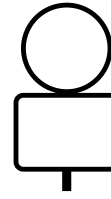

**A6434F**

Format = 700 x 500 + 600  
Format = 1000 x 700 + 600

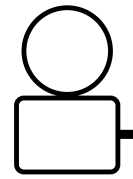

**A6434FA**

Format = 700 x 500 + 600  
Format = 1000 x 700 + 600

### Preisliste Liste de prix

Rohrmasten Ø60  
Mâts tubulaires Ø60

Seite  
page

**P1-26**

**P1-75**

**P1-75**

**P1-82**

**P1-82**

54

54

54

54

54

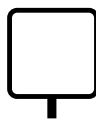

**A53F**

Format = 350  
Format = 500  
Format = 700

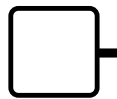

**A53F**

Format = 350  
Format = 500  
Format = 700



**A54F**

Format = 350 x 500  
Format = 500 x 700  
Format = 426 x 750  
Format = 700 x 1000

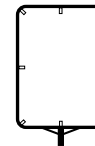

**A54F**

Format = 980 x 1355

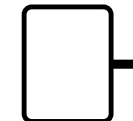

**A64F**

Format = 500 x 350  
Format = 700 x 500  
Format = 1000 x 700

**A54GF**

Format = 660 x 1000

**A54FA**

Format = 426 x 750

### Preisliste Liste de prix

Rohrmasten Ø60  
Mâts tubulaires Ø60

Seite  
page

**P1-88**

**P1-88**

**P1-96**

**P1-96**

**P1-96**

54

54

54

54

54

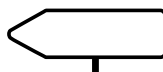

**A71F**

Format = 1020 x 200  
Format = 1020 x 250  
Format = 1020 x 450  
Format = 1300 x 200  
Format = 1300 x 250  
Format = 1300 x 300  
Format = 1300 x 350  
Format = 1300 x 450  
Format = 1300 x 550  
Format = 1300 x 650

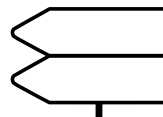

**A271F**

Format = 1020 x 200  
Format = 1020 x 250  
Format = 1300 x 200  
Format = 1300 x 250  
Format = 1300 x 300  
Format = 1300 x 350

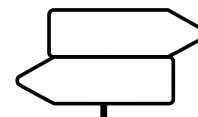

**A276F**

Format = 1020 x 200  
Format = 1020 x 250  
Format = 1300 x 200  
Format = 1300 x 250  
Format = 1300 x 300  
Format = 1300 x 350

### Preisliste Liste de prix

Rohrmasten Ø60  
Mâts tubulaires Ø60

Seite  
page

**P1-104**

**P1-110**

**P1-110**

54

54

54

## Verbindungsstück Pièce de raccordement

┆  
KUP

—  
KUP

Preisliste  
Liste de prix

**P1-5**

# Signalträger mit Jordahlschienen (Typ J) Supports de signaux avec glissière "Jordahl" (Type J)

## Rohrrahmen Cadres tubulaires

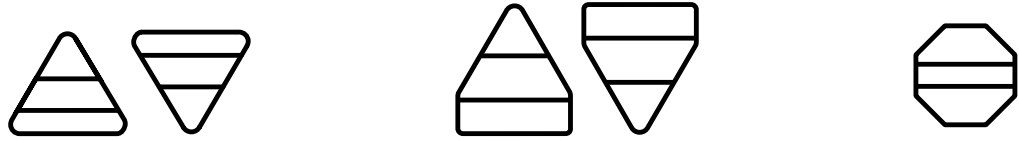

**R325J**

Format = 600  
Format = 900

Format = 1200  
Format = 1500

Halterung/Fixation  
= SNT-2606 (28/15")  
= SNT-2627 TB

Halterung/Fixation  
= SNT-2607 (36/20")  
= SNT-2628 TB

**R326J**

Format = 600  
Format = 900

Format = 1200  
Format = 1500

Halterung/Fixation  
= SNT-2606 (28/15")  
= SNT-2627 TB

Halterung/Fixation  
= SNT-2607 (36/20")  
= SNT-2628 TB

**E347J**

Format = 500  
Format = 600  
Format = 900

Halterung/Fixation  
= SNT-2606 (28/15")  
= SNT-2627 TB

Preisliste Liste de prix		P1-11	P1-28	P1-58
<b>Halterungen Fixations</b>	Seite page	53	53	53
<b>Rohrmasten Mâts tubulaires</b>	Seite page	54	54	54

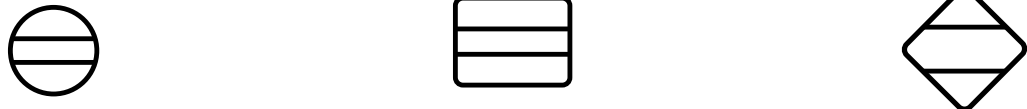

**R347J**

Format = 400  
Format = 600

Format = 900  
Format = 1200

Halterung/Fixation  
= SNT-2606 (28/15")  
= SNT-2627 TB

Halterung/Fixation  
= SNT-2607 (36/20")  
= SNT-2628 TB

**R392J**

Format = 500 x 350  
Format = 700 x 500  
Format = 900 x 700

Halterung/Fixation  
= SNT-2606 (28/15")  
= SNT-2627 TB

Format = 1000 x 700  
Format = 1250 x 900

Halterung/Fixation  
= SNT-2607 (36/20")  
= SNT-2628 TB

**R582J**

Format = 350  
Format = 500  
Format = 700  
Format = 900

Halterung/Fixation  
= SNT-2606 (28/15")  
= SNT-2627 TB

Preisliste Liste de prix		P1-40	P1-77	P1-68
<b>Halterungen Fixations</b>	Seite page	53	53	53
<b>Rohrmasten Mâts tubulaires</b>	Seite page	54	54	54

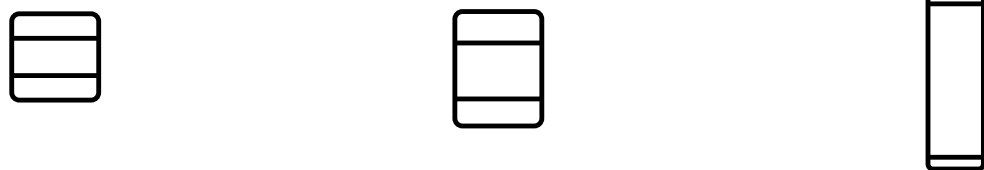

**R362J**

Format = 350  
Format = 500  
Format = 600  
Format = 700  
Format = 900

Format = 1000  
Format = 1200  
Format = 1500

Halterung/Fixation  
= SNT-2606 (28/15")  
= SNT-2627 TB

Halterung/Fixation  
= SNT-2607 (36/20")  
= SNT-2628 TB

**R382J**

Format = 350 x 500  
Format = 426 x 750  
Format = 500 x 700  
Format = 700 x 900

Halterung/Fixation  
= SNT-2606 (28/15")  
= SNT-2627 TB

Format = 700 x 1000  
Format = 900 x 1250  
Format = 900 x 1550

Halterung/Fixation  
= SNT-2607 (36/20")  
= SNT-2628 TB

**DB330J**

Format = 300 x 1000

Halterung/Fixation  
= SNT-2606 (28/15")  
= SNT-2627 TB

Preisliste Liste de prix		P1-20	P1-98	P1-118
<b>Halterungen Fixations</b>	Seite page	53	53	53
<b>Rohrmasten Mâts tubulaires</b>	Seite page	54	54	54



# Signalträger mit Jordahlschienen (Typ J) Supports de signaux avec glissière "Jordahl" (Type J)

## Rohrrahmen, Flacheisen Cadres tubulaires, cadres en fer

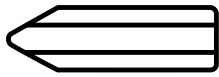

**R79J**

- Format = 1020 x 200
- Format = 1020 x 250
- Format = 1020 x 450
- Format = 1300 x 200
- Format = 1300 x 250
- Format = 1300 x 300
- Format = 1300 x 350
- Format = 1300 x 450
- Format = 1300 x 550
- Format = 1300 x 650

Halterung/Fixation  
= SNT-2606 (28/15")  
= SNT-2627 TB

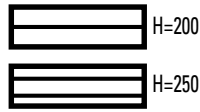

**R348J**

- (Flacheisen / Cadre en fer)
- Format =  $\bigcirc$  400
  - = 400 x 200\*
  - Format =  $\bigcirc$  500
  - = 500 x 200\*
  - Format =  $\triangle$  600
  - = 560 x 200\*
  - Format =  $\bigcirc$  600
  - = 600 x 200\*
  - Format =  $\triangle$  900
  - = 840 x 250

Halterung/Fixation  
= SNT-2606 (28/15")  
= SNT-2627 TB



**R392J**

- (Rohrrahmen / Cadre tub.)
- Format =  $\bigcirc$  900
  - = 900 x 300
  - Format =  $\triangle$  1200
  - = 1200 x 400
  - Format =  $\triangle$  1500
  - = 1500 x 500

Halterung/Fixation  
= SNT-2607 (36/20")  
= SNT-2628 TB



**R349J**

- (günstige Variante zu R348J  
Variante à prix réduit)
- Format =  $\bigcirc$  400
  - = 400 x 200\*
  - Format =  $\bigcirc$  500
  - = 500 x 200\*
  - Format =  $\triangle$  600
  - = 560 x 200\*
  - Format =  $\bigcirc$  600
  - = 600 x 200\*

Halterung/Fixation  
= SNT-2606 (28/15")  
= SNT-2627 TB

Preisliste Liste de prix		P1-88	P1-96	P1-96	P1-96
Halterungen Fixations	Seite page	53	53	53	53
Rohrmasten Mâts tubulaires	Seite page	54	54	54	54

\* mit Radius 10 / avec rayon 10

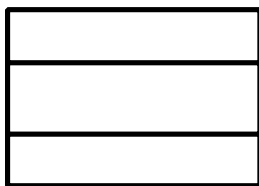

**R142VJH**

Horizontale Jordahlschienen  
Glissières "Jordahl" horizontales



**R142VJV**

Vertikale Jordahlschienen  
Glissières "Jordahl" verticales

Tafelgröße Dimensions	Halterungen Fixations
< 2.1 m <sup>2</sup>	<input type="checkbox"/> SNT-2607
2.1 - 5.0 m <sup>2</sup>	<input type="checkbox"/> SNT-2607 (Montage an 2 Masten/ Montage sur 2 mâts) <input type="checkbox"/> SNT-2607A (Montage an 1 Mast/ Montage sur 1 mât)
> 5.0 m <sup>2</sup>	<input type="checkbox"/> SNT-2614A

Halterungen Fixations	Seite page	53
--------------------------	---------------	----

Preisliste Liste de prix	
-----------------------------	--

## Signaltafel in Alu-Profilbauweise Panneaux en profilés d'aluminium

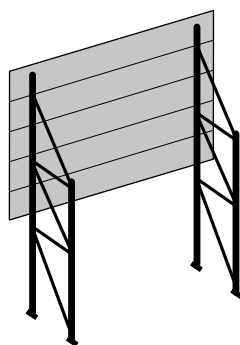

**Alu-Profil/Profilé d'aluminium**  
Format =

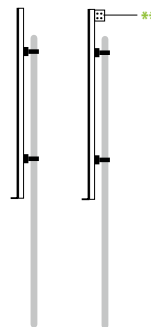

**R142M**  
T-Befestigung zu FWS/  
Menziken  
Fixation-T pour FWS/  
Menziken

Format =

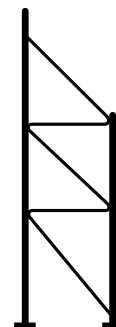

**FWS**  
Fachwerkstützen  
Supports treillis

Format =

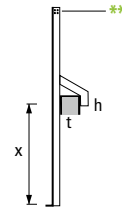

h (Höhe) / t (Tiefe)  
x (Distanz UK bis Mitte Signal)  
h (hauteur) / t (profondeur)  
x (distance NI jusqu' au milieu du signal)

**NP**  
NP-Träger mit Bügel  
Support-NP avec  
poignée

Format =

Preisliste Liste de prix	
-----------------------------	--

\*\* Beleuchtungshalter/Fixation éclairage

# Signalträger mit seitlicher Befestigung (Typ C) Supports de signaux à fixation latérale (type C)

## Rohrrahmenbefestigung an Rohrmast oder Wand Fixations de cadres tubulaires sur mâts tubulaires ou contre le mur

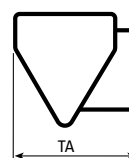
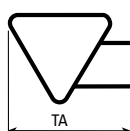
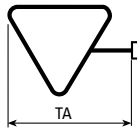
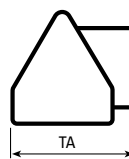
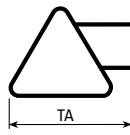
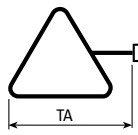

### R323C

Format = 600  
TA ( $\triangle$ 600) = 720  
TA = ... (ind.)

### R323C

Format = 900  
TA ( $\triangle$ 900) = 1030  
TA = ... (ind.)

### R324C

Format = 600  
Format = 900  
TA ( $\triangle$ 600) = 740  
TA ( $\triangle$ 900) = 1020  
TA = ... (ind.)

Sondergrößen auf Anfrage  
Grandeurs spéciales sur demande

Preisliste Liste de prix		P1-14	P1-14	P1-29
Halterungen Fixations	Seite page	53	53	53

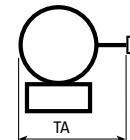
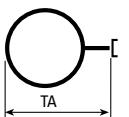
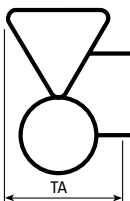
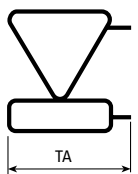

### R374C

Format = 600  
Format = 900  
TA ( $\nabla$ 600) = 730  
TA ( $\nabla$ 900) = 1030  
TA = ... (ind.)

### R54117C

Format =  $\nabla$  600,  $\circ$  400  
Format =  $\nabla$  900,  $\circ$  600  
TA (600/400) = 730  
TA (900/600) = 1030  
TA = ... (ind.)

### R541C

Format = 400  
Format = 600  
TA ( $\circ$ 400) = 690  
TA ( $\circ$ 600) = 890  
TA = ... (ind.)

### R542C

Format = 400  
Format = 600  
TA ( $\square$ 400) = 690  
TA ( $\square$ 600) = 890  
TA = ... (ind.)

Sondergrößen auf Anfrage  
Grandeurs spéciales sur demande

Preisliste Liste de prix		P1-30	P1-33	P1-41	P1-46
Halterungen Fixations	Seite page	53	53	53	53

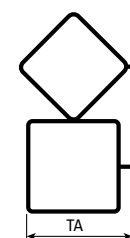
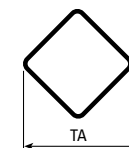
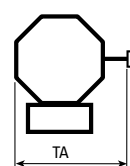
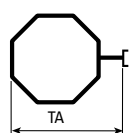

### E541C

Format = 500  
Format = 600  
Format = 900  
TA ( $\circ$ 500) = 740  
TA ( $\circ$ 600) = 840  
TA ( $\circ$ 900) = 1140  
TA = ... (ind.)

### E542C

Format = 500  
Format = 600  
TA ( $\square$ 500) = 740  
TA ( $\square$ 600) = 840  
TA = ... (ind.)

### R581C

Format = 350  
Format = 500  
Format = 700  
TA ( $\diamond$ 350) = 760  
TA ( $\diamond$ 500) = 920  
TA ( $\diamond$ 700) = 1200  
TA = ... (ind.)

### R36150C

Format =  $\diamond$  350 +  $\square$  500  
Format =  $\diamond$  500 +  $\square$  600  
TA ( $\diamond$ 350) = 700  
TA ( $\diamond$ 500) = 800  
TA = ... (ind.)

Sondergrößen auf Anfrage  
Grandeurs spéciales sur demande

Preisliste Liste de prix		P1-59	P1-63	P1-69	P1-70
Halterungen Fixations	Seite page	53	53	53	53

# Signalträger mit seitlicher Befestigung (Typ C) Supports de signaux à fixation latérale (type C)

## Rohrrahmenbefestigung an Rohrmast oder Wand Fixations de cadres tubulaires sur mâts tubulaires ou contre le mur

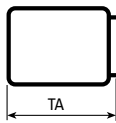

**R391C**

Format	= 500 x 350
Format	= 700 x 500
Format	= 1000 x 700
TA (500x350)	= 610
TA (700x500)	= 810
TA (1000x700)	= 1160
TA	= ...(ind.)

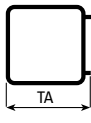

**R361C**

Format	= 350
Format	= 500
Format	= 700
Format	= 900
TA (350)	= 460
TA (500)	= 610
TA (700)	= 810
TA (900)	= 1010
TA	= ...(ind.)



**R381C**

Format	= 350 x 500
Format	= 426 x 750
Format	= 500 x 700
Format	= 700 x 1000
TA (350x500)	= 470
TA (426x750)	= 550
TA (500x700)	= 620
TA (700x1000)	= 820
TA	= ...(ind.)

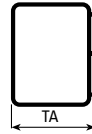

**R381C**

Format	= 900 x 1250
TA (900x1250)	= 1030
TA	= ...(ind.)



**R39134C**

Format	= 700 x 500 + 600
Format	= 1000 x 700 + 600
TA (700x500 + 600)	= 810
TA (1000x700 + 600)	= 1130
TA	= ...(ind.)

<b>Preisliste</b> <i>Liste de prix</i>		<b>P1-78</b>	<b>P1-91</b>	<b>P1-99</b>	<b>P1-99</b>	<b>P1-84</b>
<b>Halterungen</b> <i>Fixations</i>	Seite <i>page</i>	53	53	53	53	53

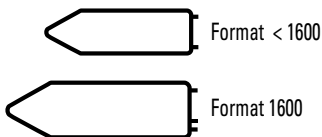

**R78C**

Format	= 1020 x 200
Format	= 1020 x 250
Format	= 1020 x 300
Format	= 1020 x 450

Format	= 1300 x 200
Format	= 1300 x 250
Format	= 1300 x 300
Format	= 1300 x 350
Format	= 1300 x 450
Format	= 1300 x 550
Format	= 1300 x 650

**R80C**

Format	= 1600 x 200
Format	= 1600 x 250
Format	= 1600 x 300

<b>Preisliste</b> <i>Liste de prix</i>		<b>P1-107</b>
<b>Halterungen</b> <i>Fixations</i>	Seite <i>page</i>	53

## Signalträger ANRST Support de signaux ANRST

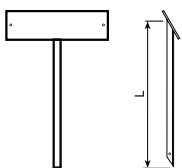

**ANRST**

Format	= 350 x 100
Format	= 400 x 200
L	= 580
L	= ...(ind.)

Signalträger für Autonummern zum Einstecken in Boden.  
Support en fer plat pour plaquettes de numéros de voitures à fixer en terre.

<b>Preisliste</b> <i>Liste de prix</i>	<b>P1-107</b>
---	---------------

# Halterungen Fixations

## mit Bride für Signalträger Typ J (Jordahl) avec bride pour support type J (Jordahl)

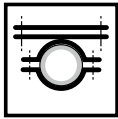

an Rohrmast oder Kandelaber  
sur mât tubulaire ou candélabre

Bride	Ø Rohrmast	Bride	Ø Rohrmast
Bride	Ø Mât tubulaire	Bride	Ø Mât tubulaire
SNT-2606 60	Ø 60 mm	SNT-2607 60	Ø 60 mm
SNT-2606 76	Ø 76 mm	SNT-2607 76	Ø 76 mm
SNT-2606 89	Ø 89 mm	SNT-2607 89	Ø 89 mm
SNT-2606 108	Ø 108 mm	SNT-2607 108	Ø 108 mm
SNT-2606 114	Ø 114 mm	SNT-2607 114	Ø 114 mm
SNT-2606 121	Ø 121 mm	SNT-2607 121	Ø 121 mm
SNT-2606 133	Ø 133 mm	SNT-2607 133	Ø 133 mm
SNT-2606 152	Ø 152 mm	SNT-2607 152	Ø 152 mm
SNT-2606 178	Ø 178 mm	SNT-2607 178	Ø 178 mm
SNT-2606 193	Ø 193 mm	SNT-2607 193	Ø 193 mm
SNT-2606 xxx	Ø ind.	SNT-2607 xxx	Ø ind.

(28/15\*) (36/20\*)

Preisliste  
Liste de prix

P1-12

## mit Bride für Signalträger Typ C avec bride pour support type C

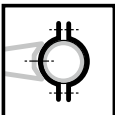

an Rohrmast oder Kandelaber  
sur mât tubulaire ou candélabre

Bride	Ø Rohrmast	Bride	Ø Rohrmast
Bride	Ø Mât tubulaire	Bride	Ø Mât tubulaire
SNT-2039 60	Ø 60 mm	SNT-2039 133	Ø 133 mm
SNT-2039 76	Ø 76 mm	SNT-2039 152	Ø 152 mm
SNT-2039 89	Ø 89 mm	SNT-2039 178	Ø 178 mm
SNT-2039 108	Ø 108 mm	SNT-2039 193	Ø 193 mm
SNT-2039 114	Ø 114 mm	SNT-2039 xxx	Ø ind.
SNT-2039 121	Ø 121 mm		

Preisliste  
Liste de prix

P1-15

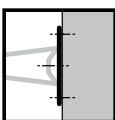

an Wand  
contre le mur

SNT-2039 W

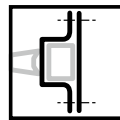

an Vierkantrahmen  
sur cadre quad.

SNT-2039 E

Preisliste  
Liste de prix

P1-16

\* Dimension der Jordahlschiene/Dimension glissière "Jordahl"

## mit Bügel für Signalträger Typ J und C avec bride pour support type J et C



an Rohrmast oder Kandelaber  
sur mât tubulaire ou candélabre

SNT-2627TB (28/15\*) SNT-2628TB (36/20\*)

Bügel für Tespaband- oder Schlauchbridenmontage für Typ J  
Bride pour montage au moyen de bandes Tespa ou de  
bracelets pour Type J



Schlauchbride oder TESPABAND  
Bracelet ou bande TESPABAND

- zur Befestigung des Bügels SNT-2628TB an Rohrmast oder Kandelaber/pour montage des brides SNT-2628TB sur mât tubulaire ou scandélabre
- zur Befestigung des Signalträgers Typ C an Rohrmast oder Kandelaber/pour montage de support type C sur mât tubulaire ou candélabre

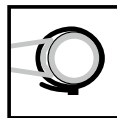

Schlauchbriden/  
Bracelets: SB6348 (Ø 42 ... 90)  
SB6364 (Ø 67 ... 114)  
SB6388 (Ø 108 ... 153)  
SBENDLOS (Ø ... 406)

"nur für Normalformat zugelassen"

"seulement autorisé pour le format normal"

TESPA-Band/ TB19 (19mmx30m)  
Bande TESPABAND: TBS19 (100 Stk./100 pce.)

Spannwerkzeug TESPABAND: TB-W

Outil de serrage TESPABAND:

Werkzeugkasten TESPABAND: TB-K (Metall, ohne Inhalt/  
Coffret TESPABAND en métal, sans contenu)

Preisliste  
Liste de prix

P1-13

## mit Briden für Signalträger R142VJ avec bride pour support de signaux R142VJ

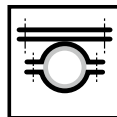

SNT-2607 (36/20\*)

Bride zu Jordahlschiene  
Bride pour glissières  
"Jordahl"

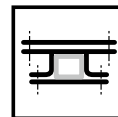

SNT-2608 (36/20\*)  
SNT-2608G (50/30\*)

Rechteckbride  
Bride rectangulaire

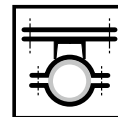

SNT-2607A (36/20\*)  
SNT-2614A (50/30\*)

Bride zu Jordahlschiene  
Bride pour glissières  
"Jordahl"

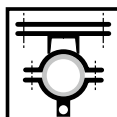

SNT-2607B (36/20\*)

SNT-2614B (50/30\*)

Bride zu Jordahlschiene  
Bride pour glissières  
"Jordahl"

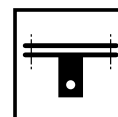

SNT-2607C (36/20\*)

SNT-2614C (50/30\*)

Traversenhalterung  
zu SNT-...B/  
Appui de poutre trans-  
versale pour SNT-...B

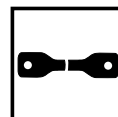

TR (Ø 42, l = ind)  
TR100 (Ø42, l = 1000)  
TR150 (Ø42, l = 1500)  
TR200 (Ø42, l = 2000)

Traverse von  
SNT-...B zu SNT-...C  
Poutre transversale de  
SNT-...B à SNT-...C

Preisliste  
Liste de prix

P1-14

1

VERKEHRSSCHILDER  
SIGNAUX ROUTIERS

SIGNAL  
ANTRIEBSSYSTEME

# Rohrmasten Mâts tubulaires

## Rohrmasten RM60 zu Signaflux Mâts tubulaires RM60 pour Signaflux

für Fundamentsockel,  
Mauerbride oder zum  
Einbetonieren  
pour socle de fondation,  
bride murale ou à bétonner

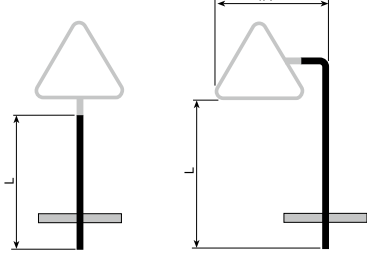

**RM60** L = 1500  
L = 2000  
L = 2400  
L = 2700  
L = 3000  
L = ... (ind.)

für Flanschbefestigung  
oder Bodenhülse  
pour flasque  
ou avec douille

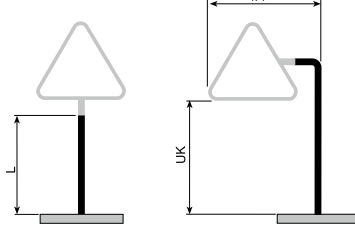

**RM60** L = 1500  
L = 2000  
L = 2400  
L = 2700  
L = 3000  
L = ... (ind.)

**RMFA60** UK = 2500  
UK = ... (ind.)  
TA = siehe Träger  
komplett Seiten  
37-47/voir supports  
complets  
pages 37-47

## Rohrmasten Mâts tubulaires

für Fundamentsockel,  
Mauerbride oder zum  
Einbetonieren  
pour socle de fondation,  
bride murale ou à bétonner

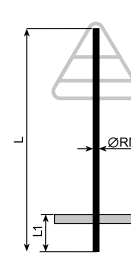

**RM60** L = 1500 L1 = 500  
L = 2000 L1 = 500  
L = 2400 L1 = 500  
L = 2700 L1 = 500  
L = 3000 L1 = 500  
L = 3300 L1 = 500  
L = 3600 L1 = 500  
L = 4000 L1 = 500  
L = ... (ind.) L1 = 500

für Flanschbefestigung  
oder Bodenhülse  
pour flasque  
ou avec douille

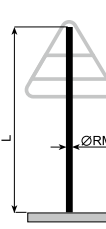

**RM60** L = 1500  
L = 2000  
L = 2400  
L = 2700  
L = 3000  
L = ... (ind.)

**RM76** L = ... (ind.)  
**RM89** L = ... (ind.)

**RM76** L = 3600 L1 = 600  
L = ... (ind.) L1 = 600

**RM89** L = 3600 L1 = 600  
L = ... (ind.) L1 = 600

Beispiel/exemple:  
RM60/1500

Beispiel/exemple:  
RMFA60/3000

Beispiele/exemples:  
RM60/1500 SCH \*  
RM60/1500 FL3  
RM60/1500 FL4

Beispiele/exemples:  
RMFA60/2500 SCH \*  
RMFA60/2500 FL3  
RMFA60/2500 FL4

Beispiel/exemple:  
RM60/1500 D

Beispiele/exemples:  
RM60/1500 SCH D \*  
RM60/1500 FL3 D  
RM60/1500 FL4 D

### Preisliste Liste de prix

**P1-6**

#### Verankerungen Ancrages

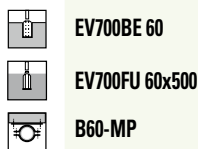

Seite  
page **53**

**P1-10**

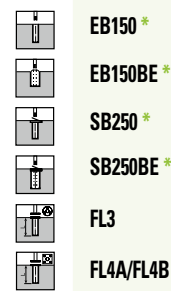

Seite  
page **53**

**P1-6**

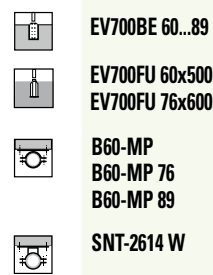

Seite  
page **53**

**P1-10**

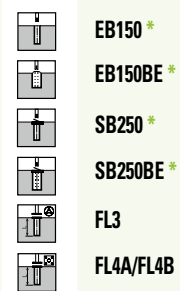

Seite  
page **53**

### Empfohlene Zuordnungen für Rohrmasten Recommandations pour mâts tubulaires

Rohrmast Mât tubulaire	Ø 60	Ø 76	Ø 89
Signale [mm] Signaux [mm]	Normalformat Format normal	Zwischenformat Format intermédiaire	Grossformat Grand format
	900 x 900 x 900	1200 x 1200 x 1200	1500 x 1500 x 1500
	500 x 700 700 x 500	700 x 1000 1000 x 700	900 x 1250 1250 x 900
	500 x 500	700 x 700	900 x 900
	600	900	1200
	600	900	1200

Statik gemäss SIA 261 bei einem Staudruck von 0,9 kN/m<sup>2</sup>. Gültig für 1 Signaltafel pro Rohrmast, Montage UK 2000 mm. / Statique selon SIA 261 pour une pression du vent de 0,9 kN/m<sup>2</sup>. Valable pour un panneau par mât tubulaire, montage du bord inférieure du panneau à une hauteur de 2000 mm.

### Oberer Abschluss des Rohrmastes Fermeture supérieure du mât tubulaire

**RM60** = oben ohne Deckel, sans couvercle en haut  
**RM60 ...D** = oben mit Deckel, avec couvercle en haut  
Beispiel/exemple: **RM60/1500 D**  
**RM76 ...D** = oben mit Deckel, avec couvercle en haut  
**RM89 ...D** = oben mit Deckel, avec couvercle en haut

\* nur für Rohr Ø 60, Rohrmasten inkl. Schloss SCH400, optional Schlüssel SCH420  
seulement pour Ø 60, mât tubulaire serrure incl. SCH400, option clé SCH420

# Verankerungen Ancrages

## Fundamentsockel, Mauerbride oder zum Einbetonieren Socle de fondation, bride murale ou à bétonner

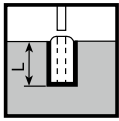

Fundamentsockel  
Socle de fondation

Ø 33 = EV700BE 33	L = 300
Ø 48 = EV700BE-K 48	L = 300
Ø 48 = EV700BE 48	L = 500
Ø 60 = EV700BE 60 *	L = 500
Ø 76 = EV700BE 76	L = 600
Ø 89 = EV700BE 89	L = 600

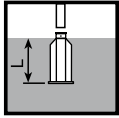

Stahlfundament  
Fondation en acier

Ø 48 = EV700FU 48X500	L = 500
Ø 60 = EV700FU 60X300	L = 300
Ø 60 = EV700FU 60X500	L = 500
Ø 76 = EV700FU 76X600	L = 600

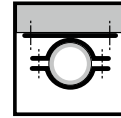

Bride zur Befestigung von  
Rohrmast an Mauer  
Bride pour fixer le mât  
tubulaire contre le mur

Ø 60 = B60-MP *
Ø 76 = B60-MP 76
Ø 89 = B60-MP 89

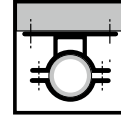

Ø ind. = SNT-2614 W \*\*

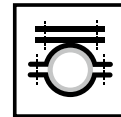

Bride zur Befestigung an WR Clip  
Bride pour fixer au WR Clip

Ø 60 = BR 60 ALU
Ø 76 = BR 76 ALU
Ø 90 = BR 90 ALU
Ø 33 = BR 33 FV

### Optionen zu EV700BE/Options pour EV700BE

Gummidichtung  
für Rohrmast  
Joint en caoutchouc  
pour mât tubulaire

Ø 33 = EV1 33
Ø 48 = EV1 48
Ø 60 = EV1 60 *
Ø 76 = EV1 76
Ø 89 = EV1 89



Abschlussdeckel  
Couvercle de fermeture

Ø 33 = EV2 33
Ø 48 = EV2 48
Ø 60 = EV2 60 *
Ø 76 = EV2 76
Ø 89 = EV2 89



Schutzkappe für  
Sechskantschraube  
Bouchon pour vis 6-pans



### Preisliste Liste de prix

P1-3



\* für Signaflex nur in dieser Grösse erhältlich  
uniquement cette dimension disponible pour  
Signaflex

## Flanschbefestigung oder Bodenhülse Flasque de fixation ou avec douille

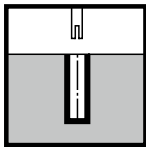

EB150

Bodenhülse  
Douille

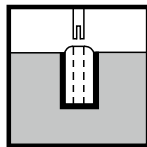

EB150BE

Bodenhülse in  
Fundament  
Socle en béton  
avec douille

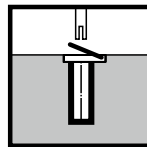

SB250

Bodenhülse mit  
schwerem Deckel  
Douille avec couvercle

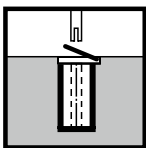

SB250BE

Bodenhülse in Funda-  
ment mit schwerem  
Deckel  
Socle en béton avec  
douille et couvercle

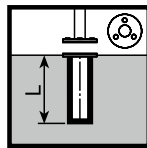

FL3

Flanschenbefestigung  
Flasque de fixation  
L = 300  
L = 400  
L = 500

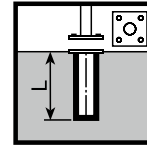

FL4A FL4B

Flanschenbefestigung  
Flasque de fixation  
Ø 150 | Ø 200  
L = 300 | L = 300  
L = 400 | L = 400  
L = 500 | L = 500

## Betonsockel für Signalträger B54 Socle en béton pour support de signaux B54



BE35 (25 kg)

Betonsockel mit  
feuerverzinktem Rohr-  
stützen für 1"-Rohr  
Socle en béton rond,  
avec tubulure galvani-  
sée pour tube 1"

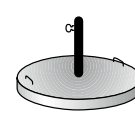

BE67 (50 kg)

Betonsockel mit Flach-  
eisenring verstärkt, mit  
feuerverzinktem Rohr-  
stützen für 1"-Rohr.  
Mit 2 Handgriffen.  
Socle en béton, renforcé  
par fer plat, avec tubu-  
lure galvanisée pour  
tube 1". Avec 2 poignées.

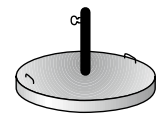

BE80 (80 kg)

Betonsockel mit Flach-  
eisenring verstärkt, mit  
feuerverzinktem Rohr-  
stützen für 1"-Rohr.  
Mit 2 Handgriffen.  
Socle en béton, renforcé  
par fer plat, avec tubu-  
lure galvanisée pour  
tube 1". Avec 2 poignées.

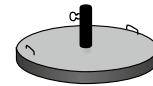

BE502 (50 kg)

Betonsockel mit Flach-  
eisen verstärkt, mit feuer-  
verzinktem Rohrstützen für  
2"-Rohr. Mit 2 Handgriffen.  
Socle en béton rond,  
renforcé par anneau fer  
plat, avec tubulure  
galvanisée pour mât tubu-  
laire 2". Avec 2 poignées.



B33 ...

L = 700
L = 1350
L = 1750
L = 2000
L =
...(ind.)

### Preisliste Liste de prix

P1-9

## Wurzelpfahl FERRADIX® Fourreau FERRADIX®

Ø 60	750027	L = 400
Ø 60	750028	L = 600
Ø 76	750030	L = 400
Ø 76	750031	L = 600
Ø 90	750032	L = 600



### Preisliste Liste de prix

P1-127

1

VERKEHRSSCHILDER  
SIGNAUX ROUTIERS

SIGNAL  
ANTRIMARK COMPANY

# Marktgebiete Zones de marché

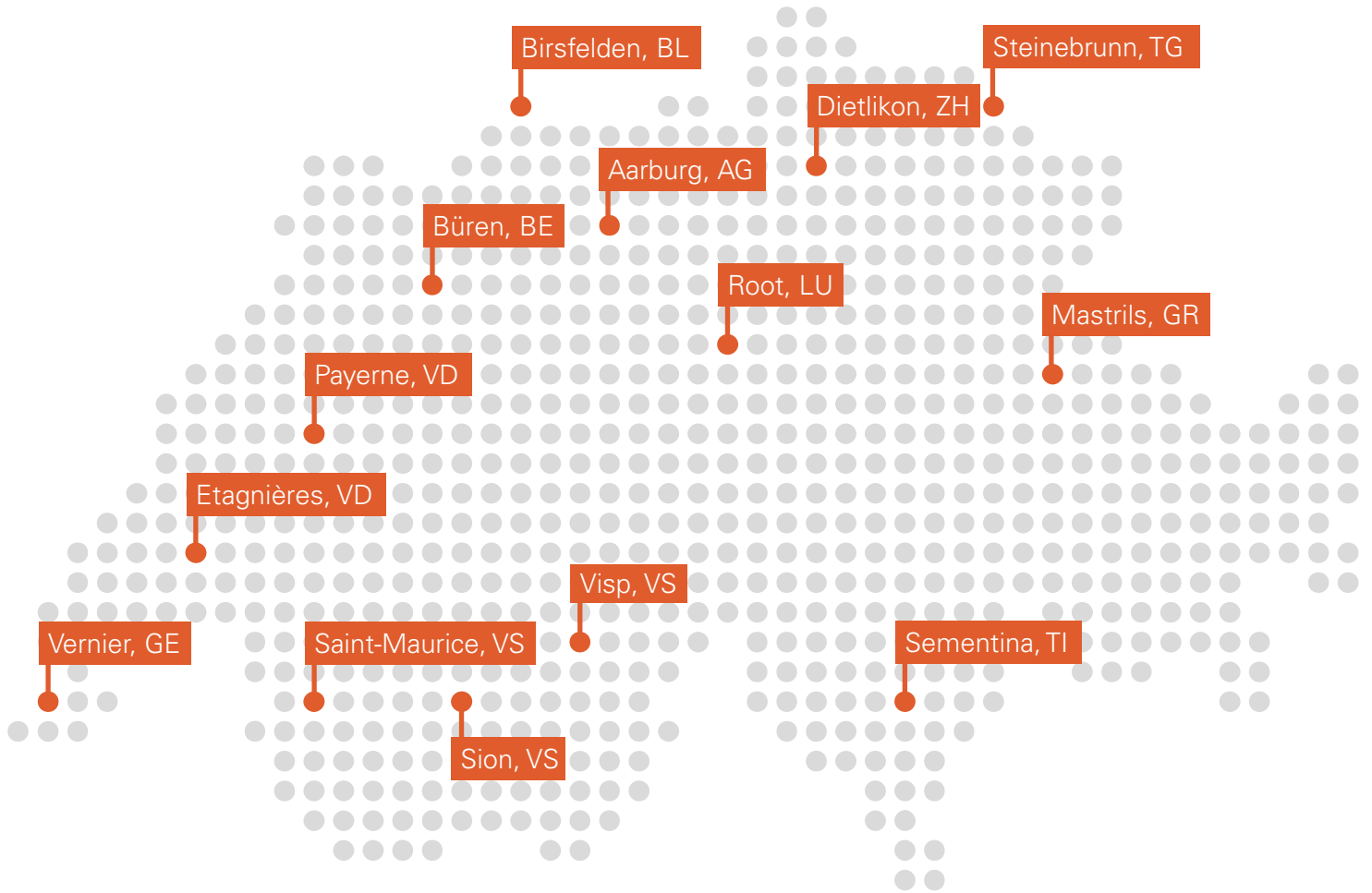

[www.signal.ch](http://www.signal.ch)

SIGNAL AG, Industriezone kleine Ey, 3294 Büren a/A, Tel. 032 352 11 11, [info@signal.ch](mailto:info@signal.ch)

Zone de marché  
Genève  
1214 Vernier  
22, ch. de Champs-Prévost  
Tél. 022 989 52 00  
[geneve@signal.ch](mailto:geneve@signal.ch)

Zone de marché  
Lavaux-Broye-Arc Jurassien  
1037 Etagnières  
Route des Ripes 2  
Tél. 021 867 11 11  
[etagnieres@signal.ch](mailto:etagnieres@signal.ch)

Zone de marché  
Bas-Valais-Central  
1951 Sion  
Rte de la Drague 14  
Tél. 027 322 39 35  
[sion@signal.ch](mailto:sion@signal.ch)

Marktgebiet  
Argovia-Basilea  
4663 Aarburg  
Bernstrasse 36  
Tel. 062 791 56 56  
[aarburg@signal.ch](mailto:aarburg@signal.ch)

Marktgebiet  
Mittelland-Lötschberg  
3294 Büren a/A  
Industriezone kleine Ey  
Tel. 032 352 11 11  
[info@signal.ch](mailto:info@signal.ch)

Marktgebiet  
Zentralschweiz  
6037 Root  
Längenbold 11  
Tel. 041 450 15 07  
[root@signal.ch](mailto:root@signal.ch)

Marktgebiet  
Ticino-Mesolcina  
6514 Sementina  
Via Pobbia 4  
Tel. 091 780 46 60  
[ticino@signal.ch](mailto:ticino@signal.ch)

Marktgebiet  
Zürich-Grischun  
8305 Dietlikon  
Neue Winterthurerstr. 30  
Tel. 043 233 32 52  
[zuerich@signal.ch](mailto:zuerich@signal.ch)

Marktgebiet  
Bodensee-Säntis  
9314 Steinebrunn  
Buhreutestrasse 1  
Tel. 071 411 20 43  
[amriswil@signal.ch](mailto:amriswil@signal.ch)